

INSTALLER MANUAL

Wood Cooking Stove







©2023 CADEL srl | All rights reserved - Tutti i diritti riservati

KOOK 60 - KOOK 80- KOOK 90
SMART 60 - SMART 80 - FRIDA 80

SUMMARY

1	MANUAL SIMBOLOGY.....	3
2	PACKAGING AND HANDLINGPACKAGING AND HANDLING	3
2.1	PACKAGING	3
2.2	REMOVING THE STOVE FROM THE PALLET	3
2.3	STOVE HANDLING.....	4
3	CHIMNEY FLUE	4
3.1	PREPARING THE SMOKE EXPULSION SYSTEM.....	4
3.2	CHIMNEY COMPONENTS	4
3.3	SMOKE DUCT (SMOKE FITTING).....	5
3.4	FLUE (CHIMNEY OR PIPED DUCT)	5
3.5	CHIMNEY POT.....	6
3.6	MAINTENANCE.....	6
4	COMBUSTION AIR	7
4.1	AIR INLET	7
5	EXAMPLES OF CORRECT INSTALLATION	8
6	INSTALLATION.....	9
6.1	INTRODUCTION	9
6.2	OVERALL DIMENSIONS	10
6.3	GENERAL INSTALLATION.....	13
6.4	LEVELLING KOOK 60.....	15
6.5	LEVELLING KOOK 80 - KOOK 90 - SMART 60 - SMART 80	15
6.6	ASSEMBLY OF DOOR HINGED TO LEFT KOOK 60	16
6.7	ELECTRIC CONNECTION	18
6.8	REMOVING THE STAINLESS STEEL PLINTH (KOOK 80 - KOOK 90 - SMART 60 - SMART 80).....	18
6.9	MOUNTING THE METAL SIDE PANELS (KOOK - SMART - FRIDA)	19
6.10	SMART 60 - SMART 80 FEET ASSEMBLY	19
6.11	MOUNTING THE FLUE GAS EXHAUST STUB PIPE...20	
7	MAINTENANCE.....	21
7.1	INTRODUCTION	21
7.2	FUME PASSAGES CLEANING KOOK 60	21
7.3	FUME PASSAGES CLEANING KOOK 90 - KOOK 80 - SMART 80 (KOOK 87).....	22
7.4	CLEANING THE SIDE FLUE GAS PASS	22
7.5	FANS CLEANING	23
7.6	REPLACING THE FAN.....	23
7.7	GASKET REPLACEMENT.....	23
7.8	OVEN LIGHT REPLACEMENT.....	23
7.9	HEART BREAK KOOK 60.....	24
7.10	HEART BREAK (KOOK 80 - 90) (SMART 60 - 80) (FRIDA 80) VALID FROM 2021.....	25
7.11	REPLACING THE STAINLESS STEEL TOP	26
7.12	REPLACING THE DOORS.....	26
8	IN CASE OF ANOMALY.....	27
8.1	PROBLEM SOLVING	27
9	TECHNICAL DATAS	28
9.1	WIRING SCHEME	28
9.2	FEATURES.....	29

1 MANUAL SIMBOLOGY

	USER
	AUTHORISED TECHNICIAN (ONLY to interpret or the Stove-manufacturer or the Authorized Technician of Technical Assistance Service approved by the Stove-manufacturer)
	SPECIALIZED STOVE-REPAIRER
	CAUTION: READ CAREFULLY THE NOTE
	CAUTION: DANGER OR IRREVERSIBLE DAMAGE POSSIBILITY

- The icons with the stylized figures indicates whom the subject dealt in the paragraph is addressed to (between the User and/or the Authorized Technician and/or the Specialized Stove-repairer).
- WARNING symbols indicates an important note.

2 PACKAGING AND HANDLING PACKAGING AND HANDLING

2.1 PACKAGING

- The packaging is made up of recyclable cardboard boxes according to RESY standards, recyclable expanded polystyrene inserts and wooden pallets.
- All packaging materials can be re-used for a similar use or eventually discharged as waste assimilable to the municipal solid ones, in accordance with current regulations.
- After having removed the packaging please assure you about the integrity of the product.

2.2 REMOVING THE STOVE FROM THE PALLET

Proceed as follows:

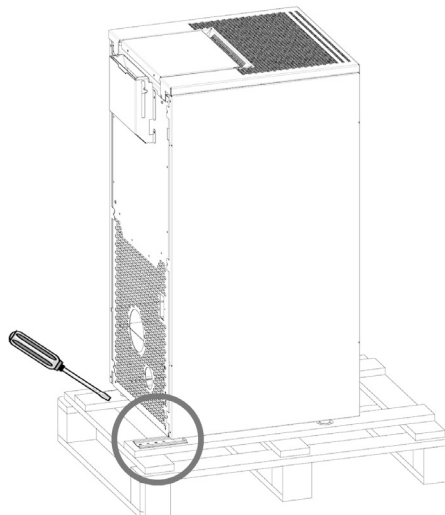

Fig. 1 - Bracket removal

- Remove the brackets which secure the feet of the stove (see **Fig. 1**). Then remove the stove from the pallet.

2.3 STOVE HANDLING

Both whether the stove is packed or not it is necessary to observe the following instructions for handling and transporting the stove from its sale point to its installation point and for any future movements:

- The stove must be handled with idoneous means paying attention to the existing safety regulations;
- do not turn the stove upside down and/or upset it on one side, but keep it in vertical position or as accorded with the constructor instructions;
- if the stove is made up of ceramic, stone, glass or any particularly fragile material components, all must be moved with the utmost care.

Two people are needed for handling operations of the stove. It is strongly recommended to reduce the weight by removing: cook top, fire door, oven door, drawer firewood holder and refractory of the fire place (see (ERRORE Destinazione riferimento incrociato 1_3893 non trovato)).

3 CHIMNEY FLUE

3.1 PREPARING THE SMOKE EXPULSION SYSTEM

The combustion product expulsion system is a particularly important element for the proper operation of the appliance and must be correctly sized according to EN 13384-1.

Its creation/adaptation/verification must always be carried out by a legally qualified operator and must comply with the regulations in force in the country where the appliance is installed.

The Manufacturer declines all liability for malfunctions caused by a badly sized and non-compliant smoke expulsion system.

3.2 CHIMNEY COMPONENTS

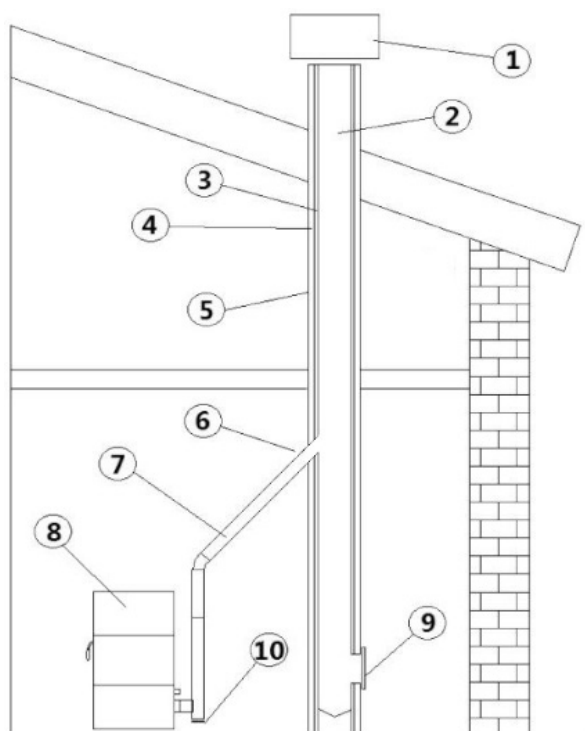

Fig. 2 - Chimney components

LEGEND	Fig. 2
1	Chimney pot
2	Fume outlet
3	Chimney flue
4	Termal insulation
5	External wall
6	Chimney union
7	Fume pipe
8	Heat generator
9	Inspection door
10	T-union with inspection plug

3.3 SMOKE DUCT (SMOKE FITTING)

The smoke duct is the pipe that connects the appliance to the flue.

This smoke fitting must comply in particular with the following requirements:

- comply with product standard EN 1856-2;
- its cross-section must be of constant diameter and no less than that of the appliance outlet, from the firebox outlet up to the connection in the flue;
- the horizontal section must be as short as possible and extend no more than 4 metres;
- the horizontal sections must have a minimum upward slope of 3%;
- changes of direction must have an angle no greater than 90° and be easy to inspect
- the number of changes of direction, including that for entry into the flue, and exclusion of the T in the event of a side or rear outlet, must not exceed 3;
- it must be insulated if it passes outside the installation room
- it must not in any case cross rooms in which it is forbidden to install combustion appliances.
- the use of flexible metal and fibre cement or aluminium hoses is forbidden;

SYSTEM TYPE	Ø150 mm PIPE	Ø240 mm PIPE
Minimum vertical length	1,5 mt	2 mt
Maximum length (with 1 union)	6,5 mt	10 mt
Maximum length (with 3 unions)	4,5 mt	8 mt
Maximum number of unions	3	3
Level section (minimum inclination 3%)	2 mt	2 mt
Installation at a height above 1200 m a.s.l.	NO	Obligatory

3.4 FLUE (CHIMNEY OR PIPED DUCT)

When creating the flue, in particular comply with the following requirements:

- comply with the applicable product standard (EN 1856, EN 1857 EN 1457, EN 1806, EN 13063..);
- be made with suitable materials to ensure resistance to normal mechanical, chemical, thermal stresses and have adequate thermal insulation in order to limit the formation of condensate;
- have a predominantly vertical configuration and be free of choke points along its entire length;
- be correctly spaced by air gaps and isolated from combustible materials;
- the flue inside the house must still be insulated and can be inserted in an air shaft provided it complies with the regulations for piping;
- the smoke duct must be connected to the flue by means of a Tee fitting with an inspectable collection chamber for the collection of soot and any condensate.
- where the sizing provides for wet operation, a suitable condensate collection and siphon discharge system must be set up.



We recommend checking the data plates of the flue for the safety distances that must be observed in the presence of combustible materials and, if necessary, the type of insulating material to be used.

It is forbidden to connect the stove to a collective or shared flue with other combustion appliances or with hood outlets.

It is forbidden to use the direct drain on the wall or towards indoor spaces and any other form of drain not provided for by the regulation in force in the country of installation.

- The chimney flue must be provided CE in accordance with EN 1443 regulation. Please find attached an example of label:



Fig. 3 - Example of label

3.5 CHIMNEY POT

The chimney pot, meaning the end part of the flue, must meet the following characteristics:

- the smoke outlet section must be at least double the internal section of the chimney;
- prevent the penetration of rain or snow;
- ensure the outlet of smoke even in the event of wind (windproof chimney pot);
- the height of outflow must be beyond the reflux area (**) (refer to national regulations to identify the reflux area);
- always be built at a distance from antennas or dishes, and never be used as a support.

(**) unless there are specific national derogations (clearly specified in the corresponding instruction manual in English) which under appropriate conditions allow it; in this case, strictly follow the product/installation requirements of the relative regulations/technical specifications/legislation in force in that country.

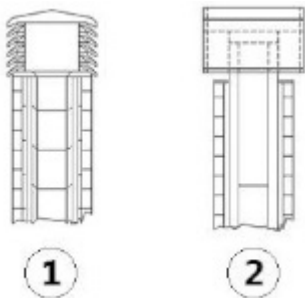

Fig. 4 - Anti-wind chimney pots

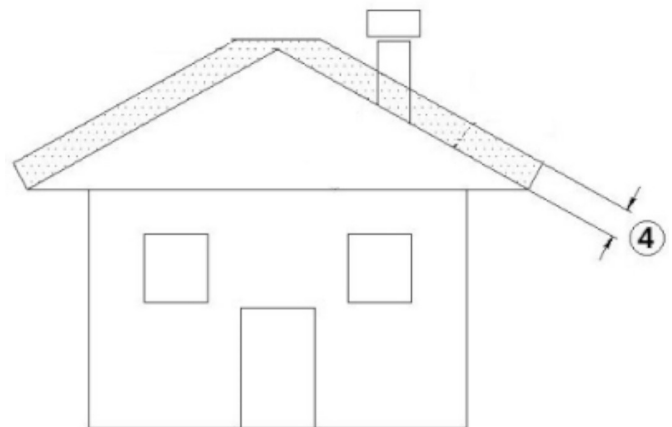

Fig. 5 - Reflux area

3.6 MAINTENANCE

- The fumes extraction pipes (fumes conduit + chimney flue + chimney pot) must always be cleaned, scrubbed and checked by an expert stove-repairer, in compliance with current regulations, with the instructions of the stove-manufacturer and the directives of your insurance company.
- In case of doubts, please follow the most restrictive regulations.
- Have your chimney flue and chimney pot checked and cleaned by an expert chimney sweep at least once a week. The chimney sweep has to release a written declaration about the security of the system.
- Not cleaning compromise safety.

4 COMBUSTION AIR

4.1 AIR INLET

It is mandatory to provide an adequate external air inlet that supplies the combustion air required for the product to work properly. The flow of air between the outside and the installation room can take place with a free air inlet or by channelling the air directly to the outside (***) .

The free air inlet must be:

- be made at floor level and in any case not higher than the height of the appliance;
- always be protected with an outer grille and in such a way that it cannot be obstructed by any object;
- have a minimum total free area of 80 cm² (net of the grille);

The presence of other suction devices (e.g.: vmc, electric fan for stale air extraction, kitchen hood, other stoves, etc.), in the same room, or in communicating rooms of the same housing unit, could cause negative pressure in the room. In this case, with the exception of sealed installations, one must verify that, with all the equipment on, no more than 4 Pa of negative pressure is created inside the installation room with respect to the outside. If necessary, increase the air inlet section.

It is possible to duct the air required for combustion to the outside by connecting the external air inlet directly with the combustion air inlet which is usually found on the back of the appliance.

The external ducted air vents must be:

- made close to the floor and anyway not higher than the appliance
- protected by a grille that guarantees a clear surface equal to the cross-section of the duct and made so that it cannot be obstructed by any object
- The air vent can be made directly on a wall of the installation room communicating with the outside, or indirectly in adjacent rooms that permanently communicate with the installation room, according to that set forth by standards in force.

The duct must comply with the following dimensions (each 90° bend is equivalent to one linear metre):

(*)** In the event the combustion air is ducted on unsealed products, still verify that no more than 4 Pa of negative pressure is created inside the installation room with respect to the outside, otherwise provide for an additional air intake in the room.

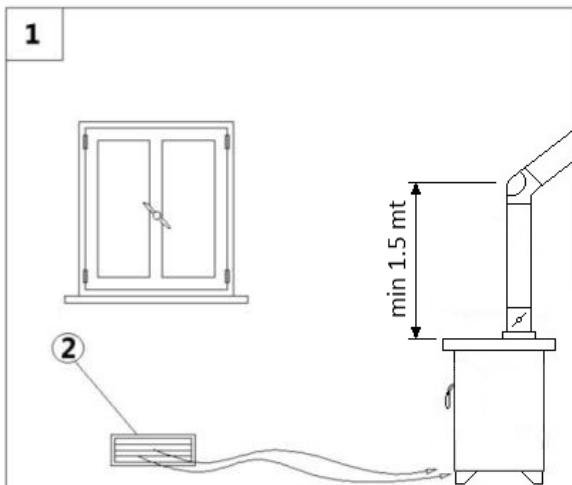

Fig. 6 - Direct air inflow

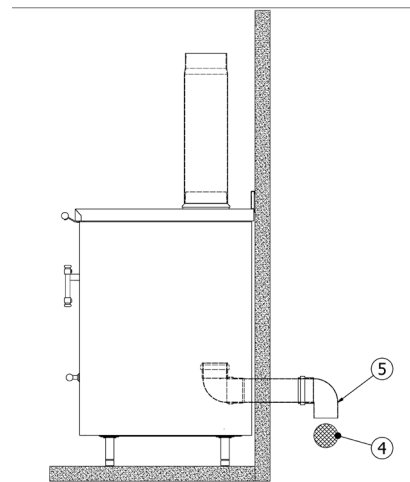

Fig. 7 - installation

LEGEND	Fig. 6 Fig. 7
1	Room to ventilate
2	External air inlet
4	Shield grid
5	Curve inlet to turn downwards

5 EXAMPLES OF CORRECT INSTALLATION

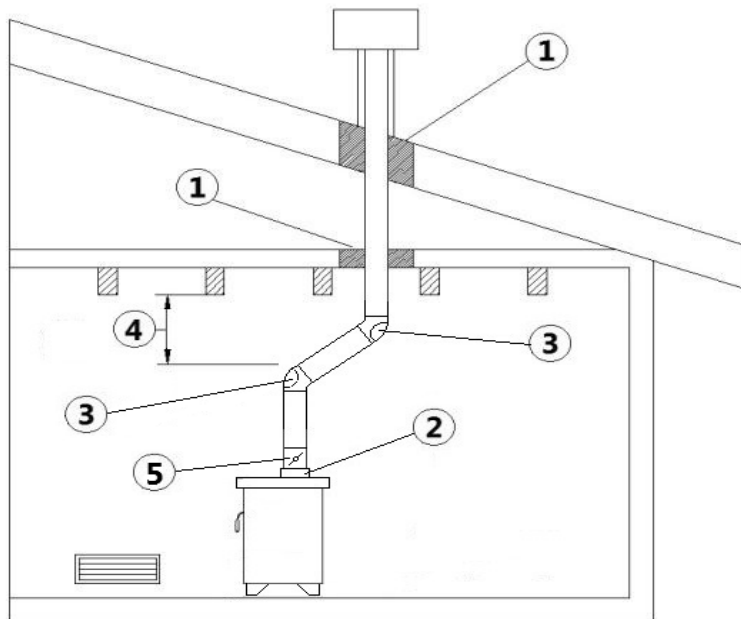

Fig. 8 - Example 1

LEGEND	Fig. 8
1	Insulating material
2	Exhaust stub pipe
3	Inspection plug
4	Minimum safety distance = 0,5 mt
5	Damper

- Chimney flue installation Ø150 mm with an enlarged drilling for pipe transit.

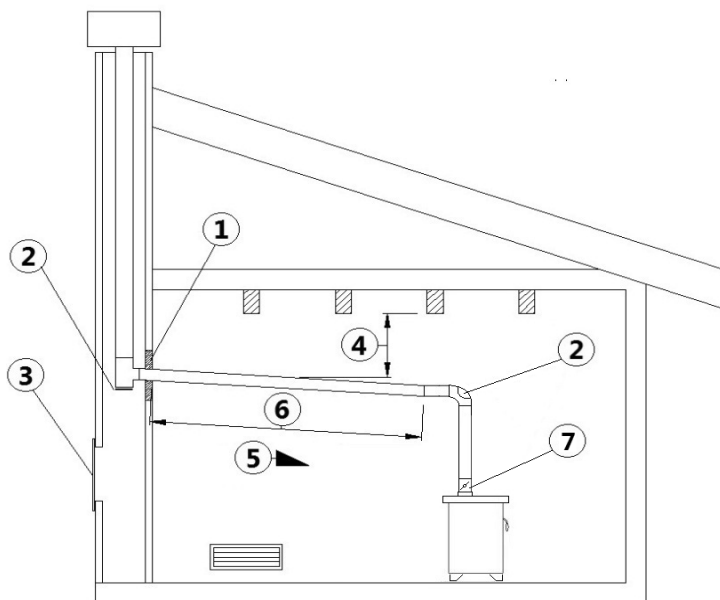

Fig. 9 - Example 2

LEGEND	Fig. 9
1	Insulating material
2	Inspection plug
3	Chimney inspection entrance
4	Minimum safety distance = 0,5 mt
5	Inclination $\geq 3^\circ$
6	Level section ≤ 1 mt

LEGEND Fig. 9

7	Damper
---	--------

- Old chimney flue with an inserted pipe of minimum $\varnothing 150$ mm and with an external door which enables the chimney cleaning.

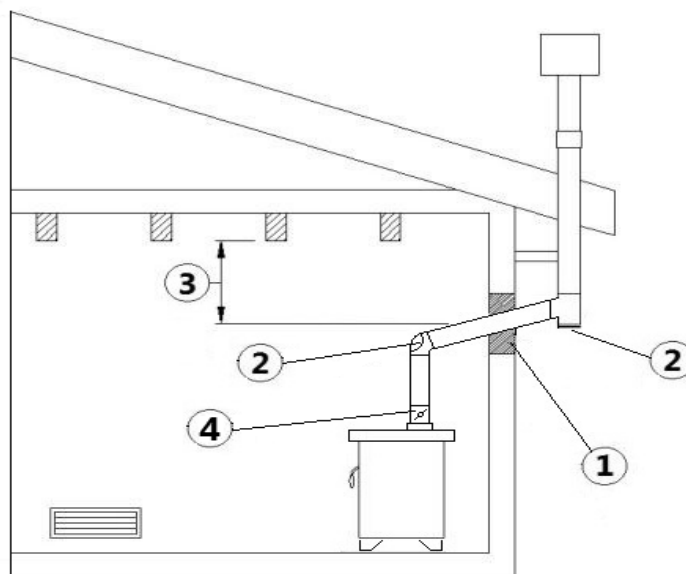
**Fig. 10 - Example 3****LEGEND Fig. 10**

1	Insulating material
2	Inspection plug
3	Minimum safety distance = 0,5 mt
4	Damper

- External chimney flue entirely made up of insulated stainless steel pipes, i.e. with double wall of minimum $\varnothing 150$ mm: all must be firmly attached to the wall. For chimney against wind effects please.
- Ducting system through T-unions which enables an easy cleaning without disassembling the pipes.



We recommend to check with your chimney flue manufacturer the safety distances which must be respected and the type of insulating material. The aforesaid regulations are valid also for holes made on the wall (EN 13501 - EN 13063 - EN 1856 - EN 1806 - EN 15827).

6 INSTALLATION

6.1 INTRODUCTION

The heating system (generator + combustion air supply + combustion product expulsion system + any hydraulic/aeraulic system) must be installed in compliance with the laws and regulations in force (*), and carried out by a qualified technician, who must issue a declaration of conformity of the system to the system manager and shall undertake full responsibility for final installation and consequent good operation of the product.

The manufacturer declines all responsibility in the event of installations that do not comply with the laws and regulations in force and inappropriate use of the appliance.

In particular one must ensure that:

- the environment is suitable for installing the appliance (floor load-bearing capacity, presence or possibility of creating an adequate electrical/hydraulic/aeraulic system when required, volume compatible with the appliance characteristics, etc.);
- the appliance is connected to a smoke expulsion system correctly sized according to EN 13384-1, which is resistant to soot fire and which complies with the distances prescribed by the combustible materials indicated on the plate data;
- there is a suitable combustion air flow to the appliance;
- other combustion appliances or extraction devices installed do not cause a negative pressure of more than 4 Pa in the room where the product is installed compared to the outside (only sealed appliances are allowed a maximum of 15 Pa of negative pressure in the room).

(*) The national reference standard for the installation of domestic appliances is UNI 10683 (IT) - DTU NF 24.1 (FR) - DIN 18896 (DE) - NBN B 61-002 (BE) - Real Decreto 1027/2007 (ES) - Paesi Bassi (NL) Bouwbesluit - Danmark (DK) BEK n° 541 del 27/04/2020.

In particular, it is recommended to strictly observe the safety distances from combustible materials to avoid serious harm to people and to the integrity of the home.

Installation of the appliance must ensure easy access to service the appliance itself, the smoke channels and the flue. Always maintain adequate distance and protection in order to prevent the product from coming into contact with water.

It is forbidden to install the stove in rooms with a fire hazard.

With the exception of sealed installations, it is also forbidden for liquid fuel appliances with continuous or intermittent operation that draw the combustion air from the room they are installed in or B-type gas heating appliances, with or without the production of domestic hot water, to coexist in the same room or in interconnecting rooms.



Sealed installation means that the product is certified as sealed and its installation (ducting of the combustion air and connection to the chimney) is airtight with respect to the installation environment.

A sealed installation does not consume the room's oxygen because it draws all the air from the outer environment (if suitably ducted) and makes it possible to install the product in all houses that require a high degree of insulation such as "passive" or "high energy efficiency" houses. Thanks to this technology there is no risk of smoke emissions in the room and no air inlets - hence not even the relevant ventilation grilles - are required in the installation premises.

Consequently, there will be more draughts of cold air in the room, thus making it more comfortable and increasing the overall efficiency of the system. The sealed stove in a sealed installation is compatible with the presence of forced ventilation or premises that might have negative pressure with respect to the outside.

6.2 OVERALL DIMENSIONS

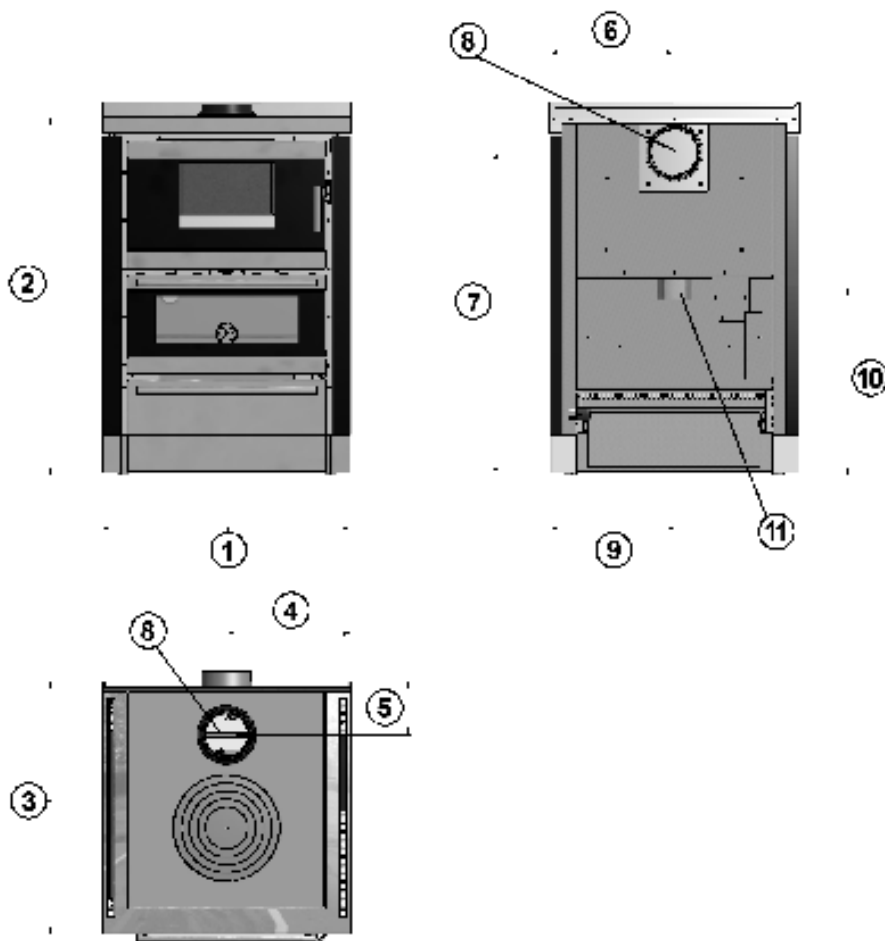

Fig. 11 - Overall dimensions: Kook 60

Please find here following the table with the measures for each stove model (see **Fig. 11**):

POS.	KOOK 60
1	60 cm
2	85/90 cm
3	60 cm
4	30 cm
5	12,7 cm
6	30 cm
7	75,5/80,5 cm
8	Exhaust fumes d.14 cm
9	30 cm
10	41/46 cm
11	Hole combustion air inlet d.8 cm

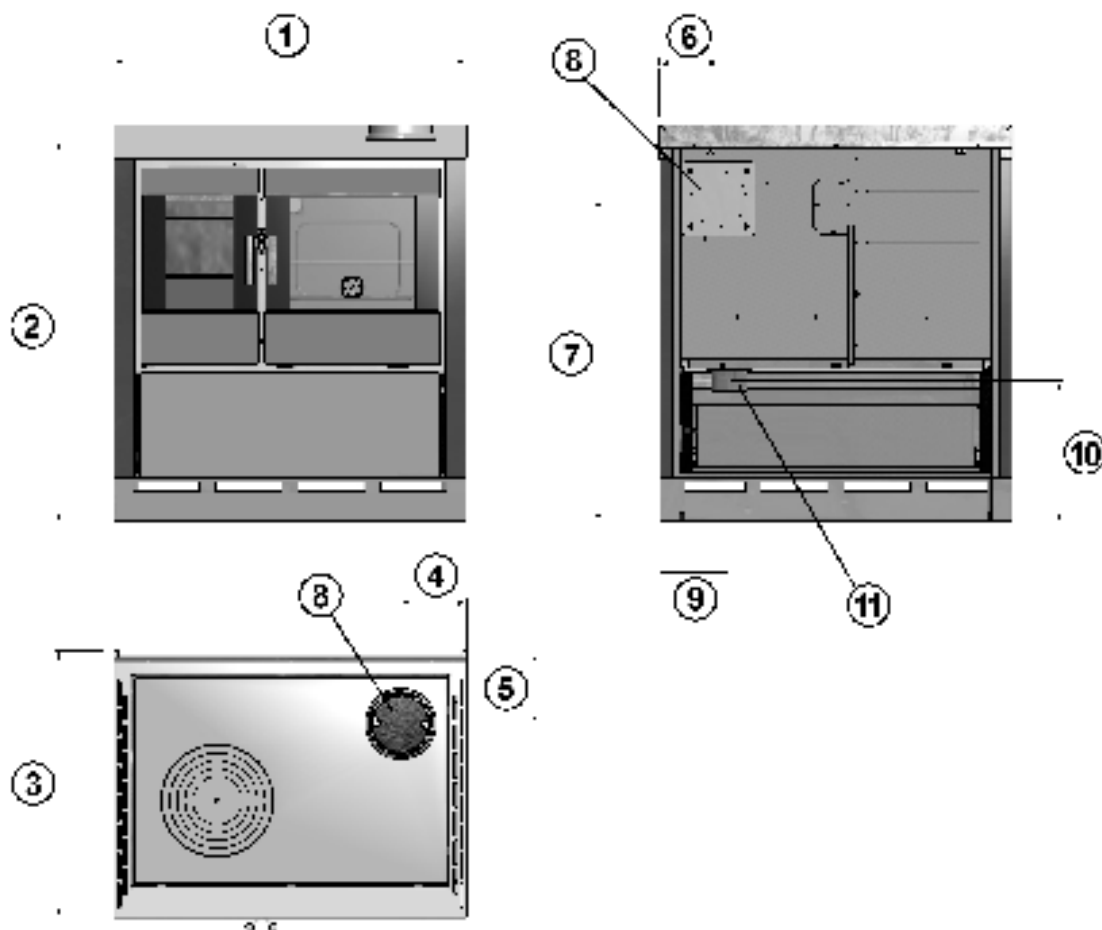

Fig. 12 - Overall dimensions: Kook 80 - Kook 90

Please find here following the table with the measures for each stove model (see **Fig. 12**):

POS.	KOOK 80 - 80V - 80S - 80 VS - FRIDA 80	KOOK 90
1	79,5 cm	89,5 cm
2	85,5 cm	85,5 cm
3	60 cm	60 cm
4	14,9 cm	14,9 cm
5	16,4 cm	16,4 cm
6	13,3 cm	20 cm

POS.	KOOK 80 - 80V - 80S - 80 VS - FRIDA 80	KOOK 90
7	72,8 cm	72,8 cm
8	Scarico fumi d.14 cm	Scarico fumi d.14 cm
9	15,9 cm	25,9 cm
10	32 cm	32 cm
11	Preso aria comburente d.8 cm	Preso aria comburente d.8 cm

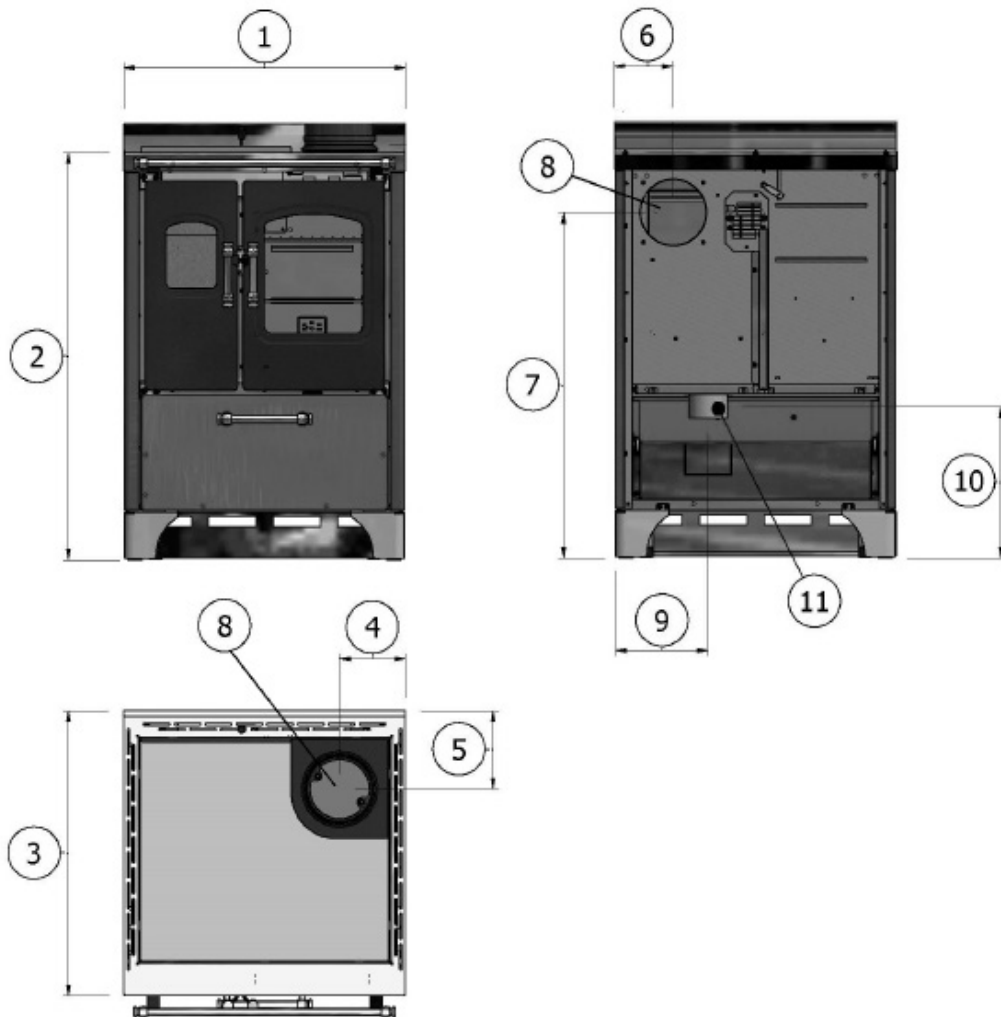

Fig. 13 - Overall dimensions: SMART 60

Please find here following the table with the measures for each stove model (see Fig. 13):

POS.	SMART 60 - SMART 60V - SMART 60S - SMART 60VS
1	59,5 cm
2	86 cm
3	60 cm
4	14 cm
5	16,5 cm
6	12,5 cm
7	73 cm
8	Scarico fumi d.14 cm
9	19,5 cm
10	32 cm
11	Preso aria comburente d.8 cm

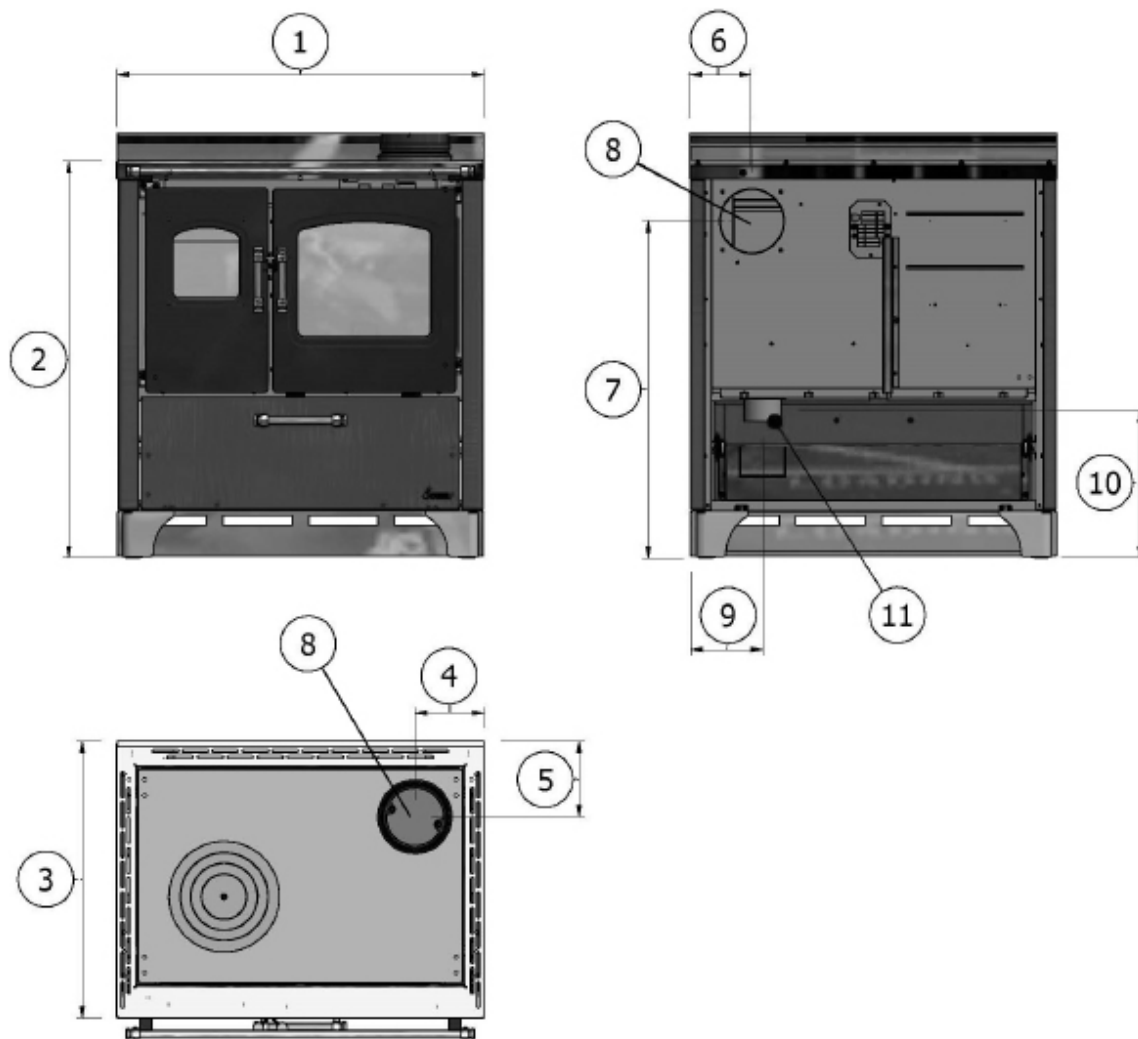

Fig. 14 - Overall dimensions: SMART 80

Please find here following the table with the measures for each stove model (see **Fig. 14**):

POS.	SMART 80 - SMART 80V - SMART 80S - SMART 80VS
1	79,5 cm
2	86 cm
3	60 cm
4	15 cm
5	16,5 cm
6	13,5 cm
7	73 cm
8	Scarico fumi d.14 cm
9	15,5 cm
10	32 cm
11	Pres a aria comburente d.8 cm

6.3 GENERAL INSTALLATION

- According to the choosed model, the wood stove can be installed apart, pulled over a wall or recessed between two walls.

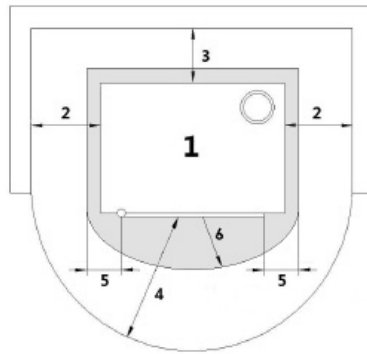

Fig. 15 - General installation

LEGEND Fig. 15

1	Stove
2	Distance from side panels under the hot plate = 2.5 mm (**except SMART 60 = 20 mm)
3	Thickness of rear flammable panel insulating material = 40 mm + Insulating material
4	1000 mm
5	50 mm
6	300 mm

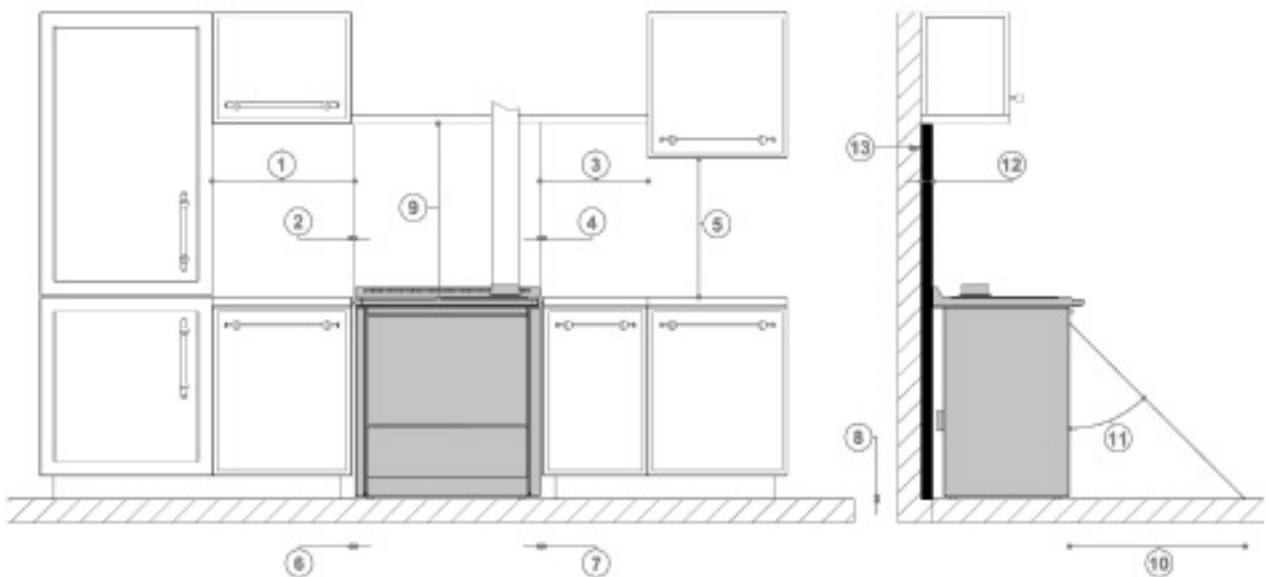

Fig. 16 - Built-in installation:

LEGEND Fig. 16

1	min. 600 mm
2	Distance from fitted units = 2.5 mm
3	min. 450 mm
4	Distance from fitted units = 2.5 mm
5	600 mm
6	Distance from side panels under the hot plate = 2.5 mm (**except SMART 60 = 20 mm)
7	Distance from side panels under the hot plate = 2.5 mm (**except SMART 60 = 20 mm)
8	Distance from flammable floor = 0 mm
9	750 mm
10	Front distance from flammable material = 1000 mm
11	45°
12	Thickness of rear flammable panel insulating material = 40 mm
13	Insulating material

- For fire regulations distances from flammable or sensible to heat materials must be respected (sofas, pieces of furniture, wood

coatings etc...) as described in **Fig. 15 e Fig. 16**].

- If highly flammable materials (curtains, carpets, etc...), all these distances must be increased of 1 meter.
- In some countries also loadbearing masonry walls are considered flammable.
- If the floor is made up of flammable material, an unburnt material cover must be realized (steel plate, refractory, marble...). For cover dimensions see **Fig. 15 e Fig. 16**].
- Check if the floor has a proper load capacity. If the existing manufacture does not reach this requirement, proper measures must be taken (for example a load distribution plate).
- If air recirculation hoods are used, they must be suitable to be used over the stove and must be placed at a distance of minimum 75 cm.

6.4 LEVELLING KOOK 60

All stove models are endowed with adjustable feet which allow a plumbed appliance and a better adaptability for recess.

- Remove the drawer.
- Adjust the feet (see **Fig. 17**).
- You can also adjust the plinth profile: loosen the screws, lower the profile and then lock the screws at the desired height (see **Fig. 18**).

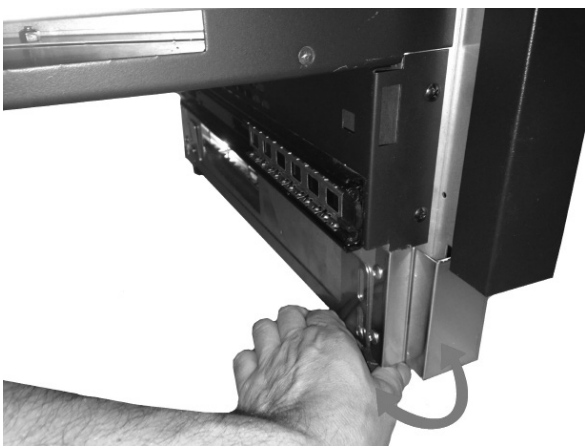

Fig. 17 - Feet adjustment: Kook 60

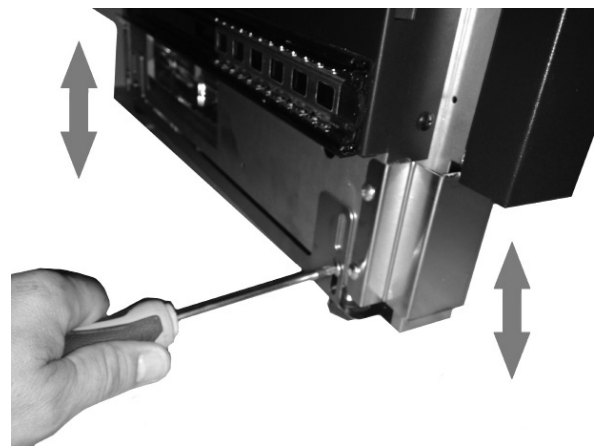

Fig. 18 - Plinth profile adjustment: Kook 60

You can also adjust the wood drawer plinth, so that it is aligned with the side plinths.

Proceed as follows:

- The inside of the drawer (see **Fig. 19**) has 3 holes containing 2 screws: remove the lower screw and loosen the upper one (see **Fig. 20**).
- Slide the drawer profile up to the same height of the side plinths (see **Fig. 21**).
- Tighten the screws.



Fig. 19 - Wood drawer



Fig. 20 - Remove/loosen screws



Fig. 21 - Profile adjustment



Pay attention to models recessed in a marble top. If the stove needs to be removed from the furniture, the feet must be lowered till the cooktop is under the marble top level and now the appliance can be removed.

6.5 LEVELLING KOOK 80 - KOOK 90 - SMART 60 - SMART 80

All stove models are endowed with adjustable feet which allow a plumbed appliance and a better adaptability for recess.

- Remove the drawer.
- Adjust the feet (see **Fig. 22**).

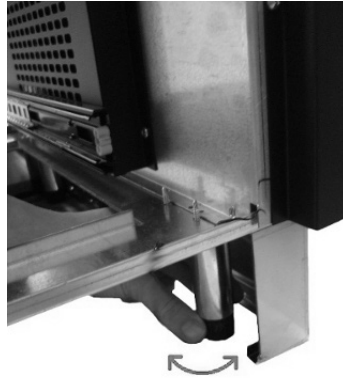

Fig. 22 - Feet adjustment: Kook 80 - Kook 90 - Smart 60 - Smart 80



Pay attention to models recessed in a marble top. If the stove needs to be removed from the furniture, the feet must be lowered till the cooktop is under the marble top level and now the appliance can be removed.

6.6 ASSEMBLY OF DOOR HINGED TO LEFT KOOK 60

The hinges on the fire door can be moved to the other side if required.



Fig. 23 - Remove the brackets

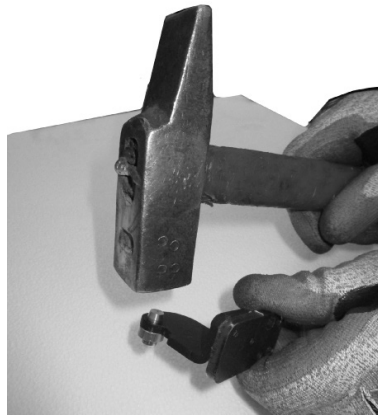

Fig. 24 - Remove the pin

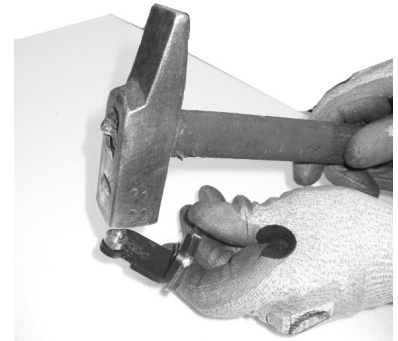

Fig. 25 - Insert the pin the other way round

- Remove the fire door (see **REPLACING THE DOORS** a pag. 26).
- Remove the brackets, undoing the 4 x CH8 screws (see **Fig. 23**).
- Remove the brass pin (see **Fig. 24**) and insert it the other way round (see **Fig. 25**).



Fig. 26 - Fix the upper bracket



Fig. 27 - Fix the lower bracket

- Fix the brackets on the right side with the 4 x CH 8 screws (see **Fig. 26** and **Fig. 27**).
- **NB: make sure that the brackets are in the correct position.**

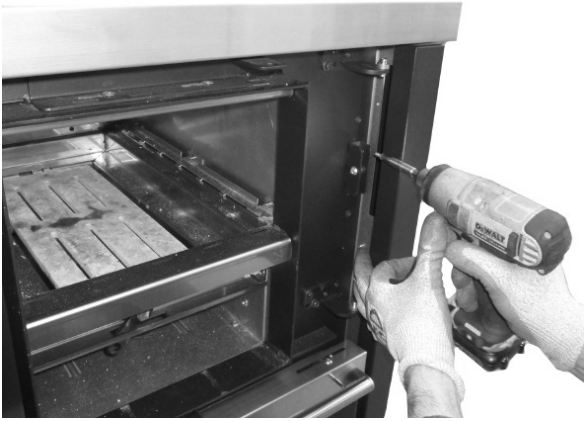

Fig. 28 - Remove the support



Fig. 29 - Fix the support

- Unscrew the door pin support (see **Fig. 28**) and screw it on the left side of the cooker (see **Fig. 29**).



Fig. 30 - Remove the handle

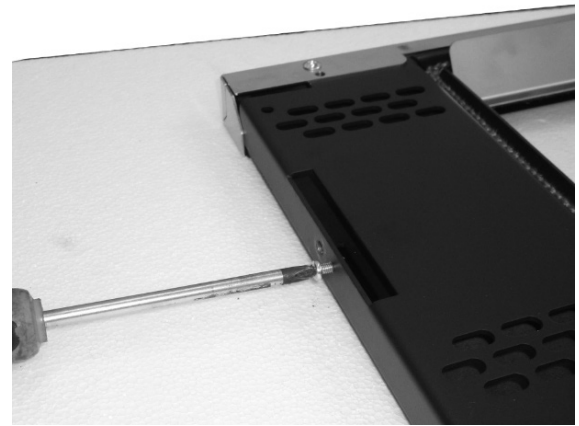

Fig. 31 - Remove the screw

- Unscrew the handle on the door (see **Fig. 30**) and the handle stop screw (see **Fig. 31**).

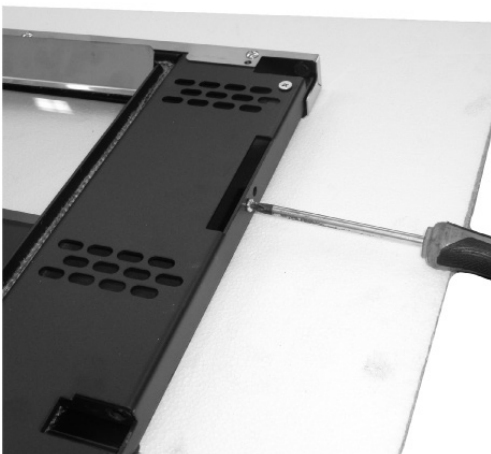

Fig. 32 - Secure the screw



Fig. 33 - Fix the handle

- Tighten the handle stop screw (see **Fig. 32**) and the handle on the opposite side of the door (see **Fig. 33**).



Fig. 34 - Fix the door locking screw



Fig. 35 - Hook the door on again

- Fasten the door stop (see **Fig. 34**) and hook the door in its new position (see **Fig. 35**).
- **NB: the screws removed from the one side must all be fastened on the other side (there must not be any empty holes in the stove).**

6.7 ELECTRIC CONNECTION

Some wood stove models are endowed with a forced ventilation system, so they need an electric connection.



Warning: the appliance must be installed by an authorized technician!

- The electric connection occurs through a cable with plug put in an electric socket which is able to support charge and tension specific of every model, as described in the technical datas table.
- The plug must be easily accessible when the appliance is installed.



The cable must not get in touch with the fume exhaust pipe and nor with every other part of the stove.

- Please further assure you that your network is endowed with an efficient earth connection: if it does not exist or if it is not efficient, please endow you with one in compliance with the law.
- Do not use extension cables.
- If the feeder cable is damaged, it must be replaced by an authorized technician.
- When the stove is not going to be used for a long period of time, it advisable to remove the plug from the socket on the wall.

6.8 REMOVING THE STAINLESS STEEL PLINTH (KOOK 80 - KOOK 90 - SMART 60 - SMART 80)

In the event of installation between kitchen units, we recommend removing the right and left hand stainless steel plinth.

- Undo the screws above the rh and lh plinth (see **Fig. 36**);
- Remove the rh and lh plinth (see **Fig. 37**).

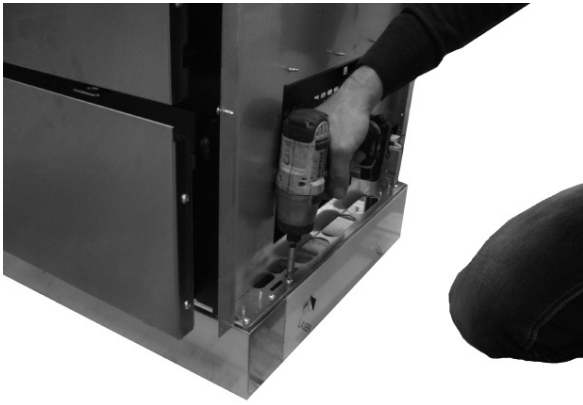

Fig. 36 - Undo the screw

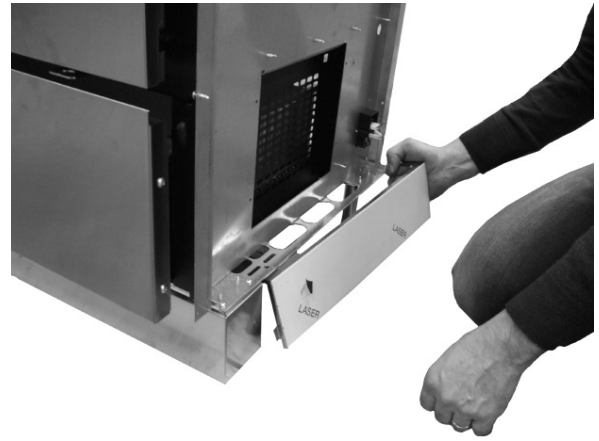

Fig. 37 - Plinth removal

If you wish you can remove the front plinth and replace it with that fitted on the kitchen units.

- Undo the screws above the front plinth (see **Fig. 38**).
- Remove the plinth (see **Fig. 39**).

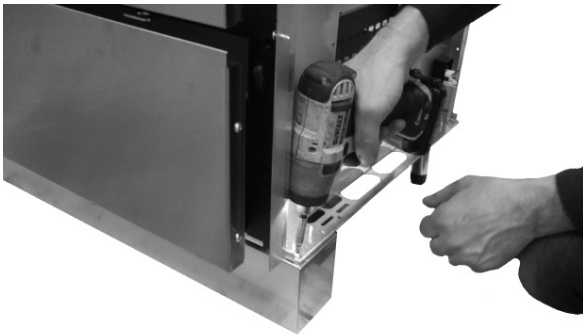

Fig. 38 - Undo the screw

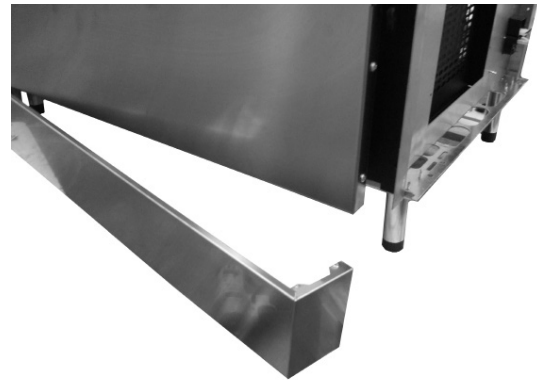

Fig. 39 - Plinth removal

6.9 MOUNTING THE METAL SIDE PANELS (KOOK - SMART - FRIDA)

- Hook the front side panel onto the screws (see **Fig. 40**).
- Loosen the rear screws (see **Fig. 41**).



Fig. 40 - Attach the side panels onto 2 screws



Fig. 41 - Fasten the side panels onto 3 screws

6.10 SMART 60 - SMART 80 FEET ASSEMBLY

The assembly of the feet (code 5020005) is optional:

- Tighten the screws (see **Fig. 42** and **Fig. 43 Fig. 44**).



Fig. 42 - Feet assembly 1

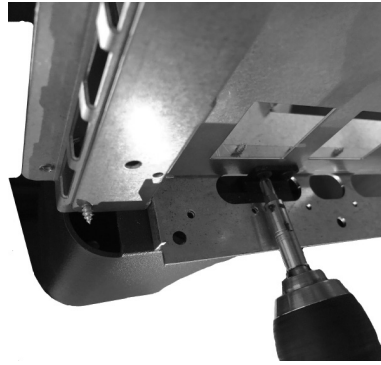

Fig. 43 - Feet assembly 2



Fig. 44 - Feet assembly 3

6.11 MOUNTING THE FLUE GAS EXHAUST STUB PIPE

All stoves have the possibility to discharge the flue gas at the top or at the back.

• Mounting the upper exhaust:

- Fasten the screw and the stops to the exhaust stub pipe (see **Fig. 45**).
- Fasten the screws with the two stops and turn them into the top (see **Fig. 46**).



Fig. 45 - Tighten the screw with the stop



Fig. 46 - Fasten the stub pipe

• Mounting the back exhaust:

- Remove the back cap (see **Fig. 47**) and tighten the 4 screws.
- Fit the stub pipe (see **Fig. 48**), tighten the screws with the two stops and turn them (see **Fig. 49**).



Fig. 47 - Cap removal



Fig. 48 - Insert the stub pipe

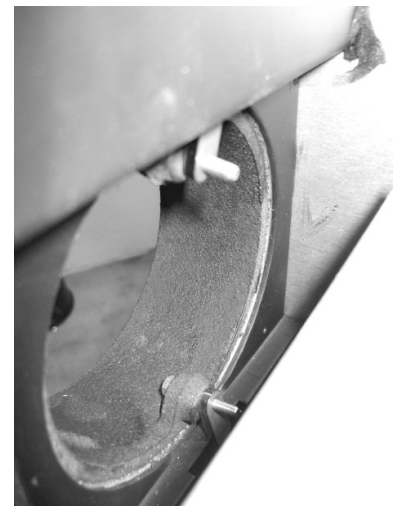

Fig. 49 - Tighten the screws

- Make sure that the upper hole of the hob is closed by the cap supplied (see **Fig. 50**).



Fig. 50 - Cap



With the back exhaust, ignition will be difficult compared to an upper exhaust. We recommend a round insulated flue with stainless steel sides.

- The horizontal duct connecting the stub pipe to the flue must be no longer than 30 cm.

7 MAINTENANCE

7.1 INTRODUCTION

For a long working life of the stove, have a periodic cleaning of the stove as described in the following paragraphs.

- Fume outlet pipes (fume conduit + chimney flue + chimney pot) must always be cleaned, scrubbed and checked by an authorized technician in compliance with local regulations, with the instructions of the manufacturer and those of your insurance company.
- If there are no local regulations and no instruction from your insurance company, it is necessary to have your fume pipe, chimney flue and chimney pot cleaned at least once a year.
- It is also necessary to have the combustion chamber, motors and fans cleaned and to have the gaskets and the electrical elements (if there are) checked at least once a year.



All these operations must be planned in time with your Authorized Technical Assistance Service.

- After a long ineffective time, before turning on the stove check if there are obstructions in the fume exhaust.
- If the stove had been using continuously and intensely, the whole system (chimney included), must be cleaned and checked more frequently.
- In case of replacement of damaged pieces please ask for the original spare part at the Authorized Retailer.

7.2 FUME PASSAGES CLEANING KOOK 60

Clean on a yearly basis (and if necessary every month) the inside of the oven flue gas pass.

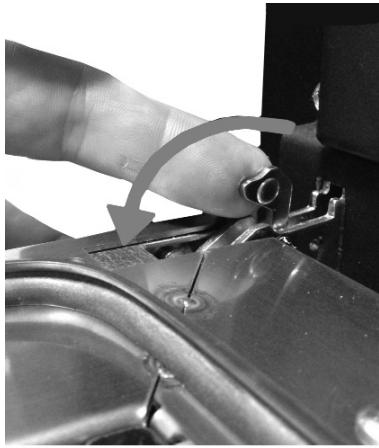

Fig. 51 - Locking lever



Fig. 52 - Oven door removal

- Open the oven door and rotate the locking lever (see **Fig. 51**).
- Remove the complete oven door (see **Fig. 52**).
- Then clean as indicated in **FUME PASSAGES CLEANING KOOK 90 - KOOK 80 - SMART 80 (KOOK 87) a pag. 22**.

7.3 FUME PASSAGES CLEANING KOOK 90 - KOOK 80 - SMART 80 (KOOK 87)

Clean on a yearly basis (and if necessary every month) the inside of the oven flue gas pass.



Fig. 53 - Remove the screws

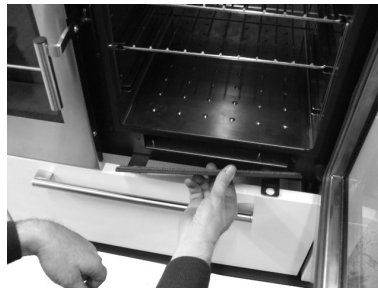

Fig. 54 - Remove the cap



Fig. 55 - Turn the valve

- Open the cleaning cap under the oven by undoing the two screws with an 8 mm spanner (see **Fig. 53** and **Fig. 54**).
- Turn the valve under the oven by 90° using the poker (see **Fig. 55**).
- Scrape and vacuum the combustion residues at the bottom of the stove.



When you have finished cleaning, ALWAYS put the cap back in place!

7.4 CLEANING THE SIDE FLUE GAS PASS

Clean on a yearly basis (and if necessary every month) the inside of the side flue gas pass.

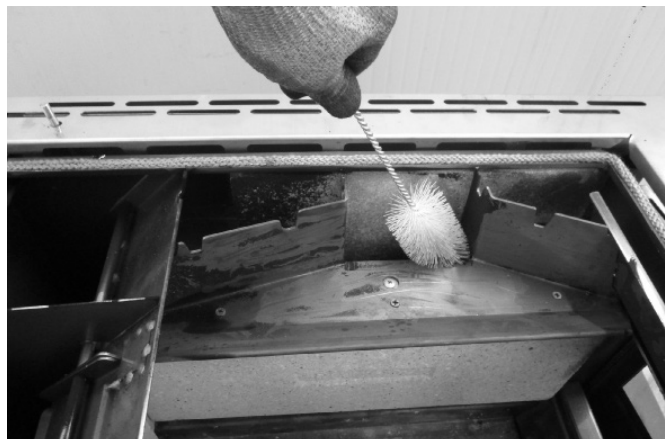

Fig. 56 - Cleaning with brush

- Clean the side fume passages with the brush provided (see **Fig. 56**).

7.5 FANS CLEANING

For models with ventilation, clean every the year the room fan from ash or dust which can cause a blade unbalance and a greater noise.

To clean the fan, proceed as follows:

- Remove the plug from the mains.
- Remove the drawer (see **Fig. 57**).
- Remove the screws of the carter that contain the fans (see **Fig. 58**).



Fig. 57 - Remove chest of drawers



Fig. 58 - Remove screws

- Release the casing and rotate everything as shown in the photo (see **Fig. 59**).
- Vacuum the ash/dust deposited inside the fan (see **Fig. 60**).
- Recompose everything.

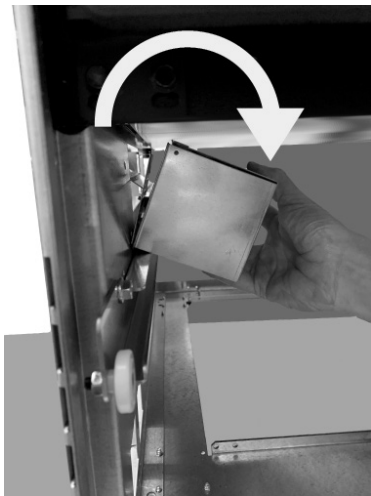

Fig. 59 - Remove blower

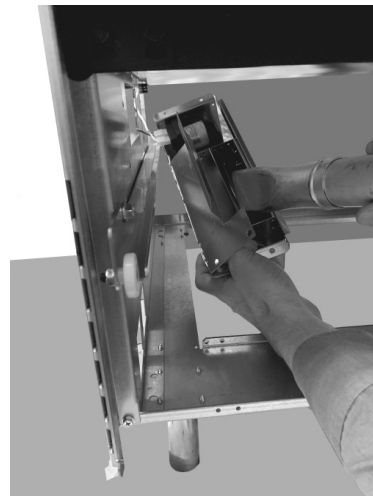

Fig. 60 - Vacuum ash/dust

7.6 REPLACING THE FAN

To replace the fan proceed as follows:

- Remove the plug from the socket.
- Remove the side panels (see relative chapter).
- Disconnect the fastons and remove the screws from the faulty fan.
- Replace the fan and repeat the operation in the reverse order.

7.7 GASKET REPLACEMENT

In case of deterioration of fire door gaskets and oven door gaskets it is necessary to replace them by an authorized technician in order to guarantee the good running of the stove.

7.8 OVEN LIGHT REPLACEMENT

Some stove models are endowed with an oven light. In case of break proceed as follow:

- Remove the plug from the socket.
- Unbolt the glass protection (vedi **Fig. 61**).
- Remove the lamp and replace it with another with the same features (15W 240V 300°C).
- Reassemble all.



Fig. 61 - Unscrew the lamp cover

Once the protection is unbolted, if necessary remove the external cooking fume remains and carefully dry it before bolting it again. For an efficient oven light it is necessary to execute a periodical light protection cleaning.

7.9 HEART BREAK KOOK 60

Probable cast iron or refractory heart break are due to an excessive overheating caused by too much fuel or by too much combustion air.

Have the damaged elements immediately replaced in order to avoid feather damages to the stove.



Fig. 62 - Remove the front profile



Fig. 63 - Anti-seize lubricant

- Remove the cast iron top.
- Remove the front profile (see **Fig. 62**).
- Spray anti-seize liquid on the screws (see **Fig. 63**).

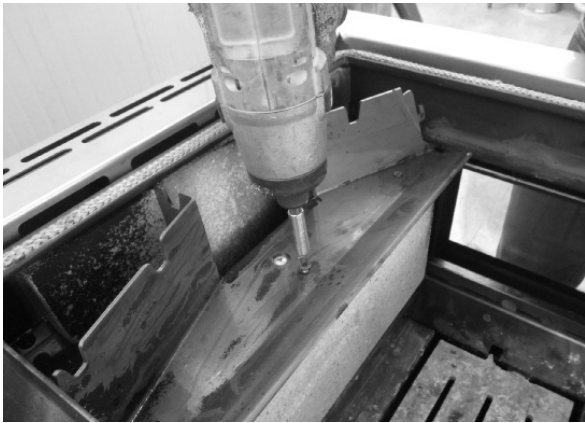

Fig. 64 - Remove the screws



Fig. 65 - Remove the profile

- Remove the screws (see **Fig. 64**).
- Remove the profile and replace the damaged refractory material (see **Fig. 65**).



Use exclusively original spare parts.

7.10 HEART BREAK (KOOK 80 - 90) (SMART 60 - 80) (FRIDA 80) VALID FROM 2021

Probable cast iron or refractory heart break are due to an excessive overheating caused by too much fuel or by too much combustion air. Have the damaged elements immediately replaced in order to avoid feather damages to the stove.



Fig. 66 - Unscrew the profile



Fig. 67 - Remove the profile



Fig. 68 - Remove the refractory material



Fig. 69 - Remove the refractory material 2



Fig. 70 - Remove the refractory material 3

- Remove the cast iron/ceramic glass top.
- Undo the screw of the profile that locks the refractory material in place (see **Fig. 66**).
- Remove the steel profile (see **Fig. 67**).
- Remove the broken refractory material and replace it (see **Fig. 68 Fig. 69 Fig. 70**).



Use exclusively original spare parts.

7.11 REPLACING THE STAINLESS STEEL TOP

In the event of a replacement, proceed as follows:



Fig. 71 - Screw removal

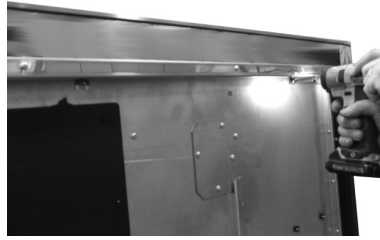

Fig. 72 - Screw removal



Fig. 73 - Remove the top

- Remove the side panels (see relative chapter).
- Loosen the 10 screws along the entire perimeter of the top without removing them (see **Fig. 71** and **Fig. 72**).
- Remove the stainless steel top (see **Fig. 73**).

7.12 REPLACING THE DOORS

In the event of a replacement, proceed as follows:



Fig. 74 - Undo the screw



Fig. 75 - Remove the door











- Loosen the door locking screw (see **Fig. 74**).
- Remove the door by releasing it from the pins (see **Fig. 75**).





8 IN CASE OF ANOMALY

8.1 PROBLEM SOLVING



In case of doubts regarding the use of the stove, please contact ALWAYS the Authorized Technician on order to avoid irreparable damages!

PROBLEM	CAUSE	SOLUTION	INTERVENTO
Ignition difficulties	Too large wood	Use small and well dried wood logs during ignition, before bigger wood logs.	
	Too humid wood	Use well seasoned wood.	
	Lack of chimney draught	Open the registers completely. (If the problem persists, contact and expert stove repairer who will check the chimney flue efficiency).	
	Ambient without air recycling	Create immediately a ventilation grid.	
Creation of condensation	Large chimney flue section	Reduce the chimney flue section with thermal insulater pipes.	
	No insulated chimney flue	Cover the chimney flue with insulating material.	
	Too slow combustion	Open air registers in order to increase the fire and fume output temperature.	
Fume leakage from the heart	No insulated chimney flue	Cover the chimney flue with insulating material.	
	Adverse wheather conditions	No windproof chimney pot: have it replaced.	
	Too humid wood	Use well seasoned wood.	

PROBLEM	CAUSE	SOLUTION	INTERVENTO
The glass blackens excessively	Lack of chimney draught	Open the registers completely. (If the problem persists, contact and expert stove repairer who will check the chimney flue efficiency).	
	Too humid wood	Use well seasoned wood	
	Too slow combustion	Open air registers in order to increase the fire and fume output temperature.	
	Bad quality fuel	Use fuel described in	
Cooker overheating	Too much wood in the heart (red coloured plate or oven over 300°C)	Close all registers and open the oven door in order to have a faster cooling.	

9 TECHNICAL DATAS

9.1 WIRING SCHEME

For models endowed with ventilation system, please follow the following wiring scheme:

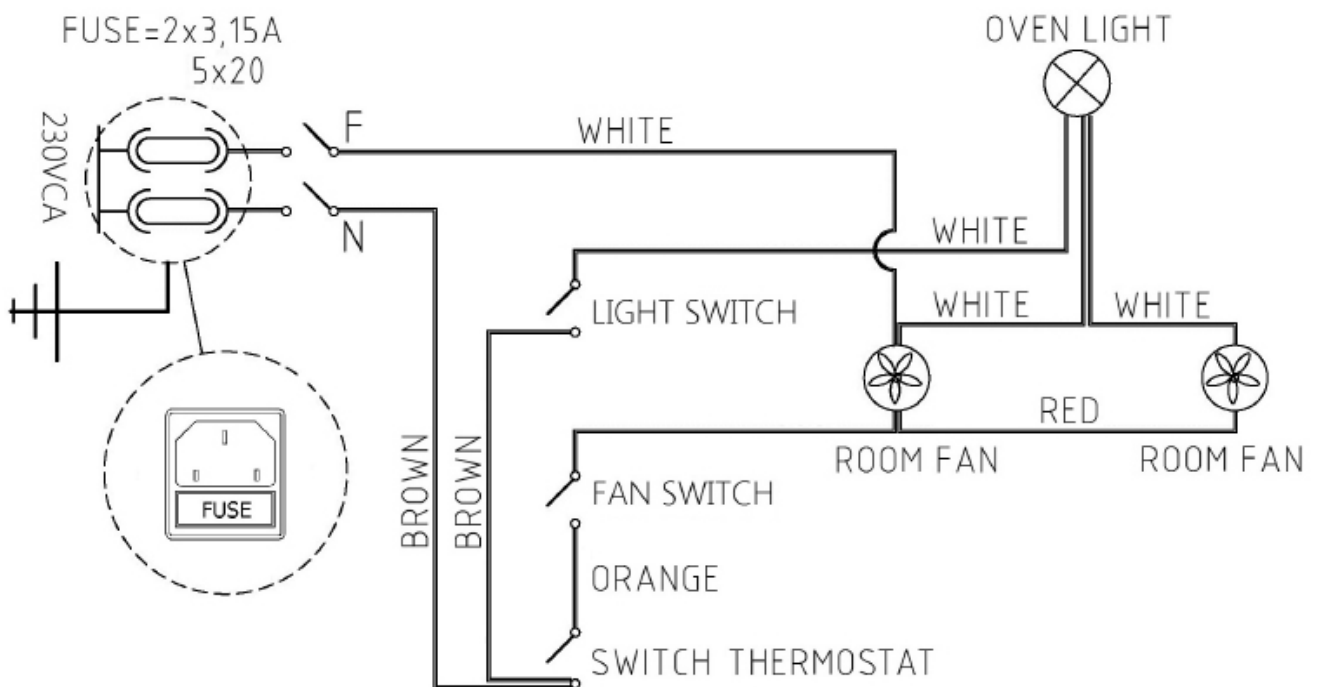

Fig. 76 - Wiring scheme

9.2 FEATURES

DESCRIPTION	KOOK 60	KOOK 80	KOOK 90	KOOK 80 S
WIDTH	59,5 cm	79,5 cm	89,5 cm	79,5 cm
DEPTH	60 cm	60 cm	60 cm	60 cm
HEIGHT	85-90 cm	86 cm	86 cm	86 cm
WEIGHT	121,6 kg	138,2 kg	147,2 kg	138,2 kg
NOMINAL HEAT OUTPUT (Max)	6,2 kW	7,5 kW	7,5 kW	7,5 kW
THERMAL EFFICIENCY (Max)	84,1 %	82,5 %	82,5 %	85,5 %
FLUE GAS TEMPERATURE (Max)	168 °C	264 °C	264 °C	179 °C
MAXIMUM FLUE GAS FLOW RATE (Max)	7,3 g/s	6,9 g/s	6,9 g/s	7,1 g/s
CO EMISSIONS (13% O ₂) (Max)	0,097 %	0,07 %	0,07 %	0,094 %
Average CONTENT of CO (13% O ₂) (Max)	1209 mg/Nm ³	916 mg/Nm ³	916 mg/Nm ³	1167 mg/Nm ³
OGC EMISSIONS (13% O ₂) (Max)	69 mg/Nm ³	29 mg/Nm ³	29 mg/Nm ³	69 mg/Nm ³
NOX EMISSIONS (13% O ₂) (Max)	78 mg/Nm ³	95 mg/Nm ³	95 mg/Nm ³	85 mg/Nm ³
DUST CONTENT (13% O ₂)	29,8 mg/Nm ³	27 mg/Nm ³	27 mg/Nm ³	20 mg/Nm ³
FLUE NEGATIVE PRESSURE (Max)	12 Pa	12 Pa	12 Pa	12 Pa
FLUE GAS EXHAUST DIAMETER	140 mm	140 mm	140 mm	140 mm
MANDATORY DAMPER	NO	NO	NO	NO
FUEL	WOOD	WOOD	WOOD	WOOD
WOOD MOISTURE CONTENT (Max)	13,3 %	13,3 %	13,3 %	13,3 %
LOG LENGTH	33 cm	33 cm	33 cm	33 cm
LOG WEIGHT	1,6 kg	2,2 kg	2,2 kg	2,1 kg
HEATABLE VOLUME 18/20°C Coeff. 0.045 kW (Max)	149 m ³	180 m ³	180 m ³	180 m ³
HEARTH VOLUME	23,8 dm ³	19,2 dm ³	19,2 dm ³	19,2 dm ³
HEARTH INLET	3,8 dm ³	2,9 dm ³	2,9 dm ³	2,9 dm ³
HEARTH INLET DIMENSIONS (WxH)	26,1x14,4 cm	17,2x16,7 cm	17,2x16,7 cm	17,2x16,7 cm
HEARTH DIMENSIONS (WxDxH)	22,9x40x26 cm	21,5x41,5x21,5 cm	21,5x41,5x21,5 cm	21,5x41,5x21,5 cm
OVEN DIMENSIONS (WxDxH)	37x34x16,5 cm	33x42x29 cm	33x42x29 cm	33x42x29 cm
ASH PAN CAPACITY	4,7 dm ³	5,6 dm ³	5,6 dm ³	5,6 dm ³
ROTATING HEARTH GRILLE	YES	YES	YES	YES
ADJUSTABLE PRIMARY AIR	YES	YES	YES	YES
ADJUSTABLE SECONDARY AIR	YES	YES	YES	YES
VENTILATION	NO	NO	NO	NO
POWER SUPPLY	-	-	-	-
ABSORBED POWER (Max)	-	-	-	-
EXTERNAL AIR VENT (CROSS-SECTION) (Min)	100 cm ²	100 cm ²	100 cm ²	100 cm ²
EXTERNAL COMBUSTION AIR CONNECTION PIPE DIAMETER (MAXIMUM LENGTH 2 m)	80 mm	80 mm	80 mm	80 mm
DISTANCE FROM COMBUSTIBLE MATERIAL (back/side/bottom)	45 / 2,5 / 0 mm	40 / 2,5 / 0 mm	40 / 2,5 / 0 mm	40 / 2,5 / 0 mm
DISTANCE FROM COMBUSTIBLE MATERIAL (ceiling/front)	750 / 1000 mm	750 / 1000 mm	750 / 1000 mm	750 / 1000 mm

DESCRIPTION	KOOK 60 V	KOOK 80 V	KOOK 90 V	KOOK 80 VS
WIDTH	59,5 cm	79,5 cm	89,5 cm	79,5 cm
DEPTH	60 cm	60 cm	60 cm	60 cm
HEIGHT	85-90 cm	86 cm	86 cm	86 cm
WEIGHT	121,6 kg	138,2 kg	147,2 kg	138,2 kg
NOMINAL HEAT OUTPUT (Max)	6,2 kW	7,5 kW	7,5 kW	7,5 kW
THERMAL EFFICIENCY (Max)	84,1 %	84 %	84 %	85,5 %
FLUE GAS TEMPERATURE (Max)	168 °C	258 °C	258 °C	179 °C
MAXIMUM FLUE GAS FLOW RATE (Max)	7,3 g/s	6,1 g/s	6,1 g/s	7,1 g/s
CO EMISSIONS (13% O ₂) (Max)	0,097 %	0,07 %	0,07 %	0,094 %
Average CONTENT of CO (13% O ₂) (Max)	1209 mg/Nm ³	856 mg/Nm ³	856 mg/Nm ³	1167 mg/Nm ³
OGC EMISSIONS (13% O ₂) (Max)	69 mg/Nm ³	45 mg/Nm ³	45 mg/Nm ³	69 mg/Nm ³
NOX EMISSIONS (13% O ₂) (Max)	78 mg/Nm ³	60 mg/Nm ³	60 mg/Nm ³	85 mg/Nm ³
DUST CONTENT (13% O ₂)	29,8 mg/Nm ³	26 mg/Nm ³	26 mg/Nm ³	20 mg/Nm ³
FLUE NEGATIVE PRESSURE (Max)	12 Pa	12 Pa	12 Pa	12 Pa
FLUE GAS EXHAUST DIAMETER	140 mm	140 mm	140 mm	140 mm
MANDATORY DAMPER	NO	NO	NO	NO
FUEL	WOOD	WOOD	WOOD	WOOD
WOOD MOISTURE CONTENT (Max)	13,3 %	13,3 %	13,3 %	13,3 %
LOG LENGTH	33 cm	33 cm	33 cm	33 cm
LOG WEIGHT	1,6 kg	2,2 kg	2,2 kg	2,1 kg
HEATABLE VOLUME 18/20°C Coeff. 0.045 kW (Max)	149 m ³	180 m ³	180 m ³	180 m ³
HEARTH VOLUME	23,8 dm ³	19,2 dm ³	19,2 dm ³	19,2 dm ³
HEARTH INLET	3,8 dm ³	2,9 dm ³	2,9 dm ³	2,9 dm ³
HEARTH INLET DIMENSIONS (WxH)	26,1x14,4 cm	17,2x16,7 cm	17,2x16,7 cm	17,2x16,7 cm
HEARTH DIMENSIONS (WxDxH)	22,9x40x26 cm	21,5x41,5x21,5 cm	21,5x41,5x21,5 cm	21,5x41,5x21,5 cm
OVEN DIMENSIONS (WxDxH)	37x34x16,5 cm	33x42x29 cm	33x42x29 cm	33x42x29 cm
ASH PAN CAPACITY	4,7 dm ³	5,6 dm ³	5,6 dm ³	5,6 dm ³
ROTATING HEARTH GRILLE	YES	YES	YES	YES
ADJUSTABLE PRIMARY AIR	YES	YES	YES	YES
ADJUSTABLE SECONDARY AIR	YES	YES	YES	YES
VENTILATION	YES	YES	YES	YES
POWER SUPPLY	230V - 50Hz	230V - 50Hz	230V - 50Hz	230V - 50Hz
ABSORBED POWER (Max)	50 W	50 W	50 W	50 W
EXTERNAL AIR VENT (CROSS-SECTION) (Min)	100 cm ²	100 cm ²	100 cm ²	100 cm ²
EXTERNAL COMBUSTION AIR CONNECTION PIPE DIAMETER (MAXIMUM LENGTH 2 m)	80 mm	80 mm	80 mm	80 mm
DISTANCE FROM COMBUSTIBLE MATERIAL (back/side/bottom)	45 / 2,5 / 0 mm	40 / 2,5 / 0 mm	40 / 2,5 / 0 mm	40 / 2,5 / 0 mm
DISTANCE FROM COMBUSTIBLE MATERIAL (ceiling/front)	750 / 1000 mm	750 / 1000 mm	750 / 1000 mm	750 / 1000 mm

DESCRIPTION	FRIDA 80	KOOK 80S	KOOK 80VS
WIDTH	79,5 cm	79,5 cm	79,5 cm
DEPTH	60 cm	60 cm	60 cm
HEIGHT	86 cm	86 cm	86 cm
WEIGHT	152 kg	138.2 kg	138.2 kg
NOMINAL HEAT OUTPUT (Max)	7,5 kW	7,5 kW	7,5 kW
THERMAL EFFICIENCY (Max)	85,5 %	85,5 %	85,5 %
FLUE GAS TEMPERATURE (Max)	179 °C	179 °C	179 °C
MAXIMUM FLUE GAS FLOW RATE (Max)	7,1 g/s	7,1 g/s	7,1 g/s
CO EMISSIONS (13% O ₂) (Max)	0,094 %	0,094 %	0,094 %
Average CONTENT of CO (13% O ₂) (Max)	1167 mg/Nm ³	1167 mg/Nm ³	1167 mg/Nm ³
OGC EMISSIONS (13% O ₂) (Max)	69 mg/Nm ³	69 mg/Nm ³	69 mg/Nm ³
NOX EMISSIONS (13% O ₂) (Max)	85 mg/Nm ³	85 mg/Nm ³	85 mg/Nm ³
DUST CONTENT (13% O ₂)	20 mg/Nm ³	20 mg/Nm ³	20 mg/Nm ³
FLUE NEGATIVE PRESSURE (Max)	12 Pa	12 Pa	12 Pa
FLUE GAS EXHAUST DIAMETER	140 mm	140 mm	140 mm
MANDATORY DAMPER	NO	NO	NO
FUEL	LEGNO	LEGNO	LEGNO
WOOD MOISTURE CONTENT (Max)	13,3 %	13,3 %	13,3 %
LOG LENGTH	33 cm	33 cm	33 cm
LOG WEIGHT	2,1 kg	2,1 kg	2,1 kg
HEATABLE VOLUME 18/20°C Coeff. 0.045 kW (Max)	180 m ³	180 m ³	180 m ³
HEARTH VOLUME	19,2 dm ³	19,2 dm ³	19,2 dm ³
HEARTH INLET	2,9 dm ³	2,9 dm ³	2,9 dm ³
HEARTH INLET DIMENSIONS (WxH)	17,2x16,7 cm	17,2x16,7 cm	17,2x16,7 cm
HEARTH DIMENSIONS (WxDxH)	21,5x41,5x21,5 cm	21,5x41,5x21,5 cm	21,5x41,5x21,5 cm
OVEN DIMENSIONS (WxDxH)	33x42x29 cm	33x42x29 cm	33x42x29 cm
ASH PAN CAPACITY	5,6 dm ³	5,6 dm ³	5,6 dm ³
ROTATING HEARTH GRILLE	SI	SI	SI
ADJUSTABLE PRIMARY AIR	SI	SI	SI
ADJUSTABLE SECONDARY AIR	SI	SI	SI
VENTILATION	NO	NO	SI
POWER SUPPLY	-	-	230V - 50Hz
ABSORBED POWER (Max)	-	-	50 W
EXTERNAL AIR VENT (CROSS-SECTION) (Min)	100 cm ²	100 cm ²	100 cm ²
EXTERNAL COMBUSTION AIR CONNECTION PIPE DIAMETER (MAXIMUM LENGTH 2 m)	80 mm	80 mm	80 mm
DISTANCE FROM COMBUSTIBLE MATERIAL (back/side/bottom)	40 / 2,5 / 0 mm	40 / 2,5 / 0 mm	40 / 2,5 / 0 mm
DISTANCE FROM COMBUSTIBLE MATERIAL (ceiling/front)	750 / 1000 mm	750 / 1000 mm	750 / 1000 mm

DESCRIPTION	SMART 60	SMART 60S	SMART 80	SMART 80S
WIDTH	59,5 cm	59,5 cm	79,5 cm	79,5 cm
DEPTH	60 cm	60 cm	60 cm	60 cm
HEIGHT	86 cm	86 cm	86 cm	86 cm
WEIGHT	123 kg	123 kg	152 kg	152 kg
NOMINAL HEAT OUTPUT (Max)	6,5 kW	6,5 kW	7,5 kW	7,5 kW
THERMAL EFFICIENCY (Max)	85,1 %	85,1 %	85,5 %	85,5 %
FLUE GAS TEMPERATURE (Max)	185 °C	185 °C	179 °C	179 °C
MAXIMUM FLUE GAS FLOW RATE (Max)	6,3 g/s	6,3 g/s	7,1 g/s	7,1 g/s
CO EMISSIONS (13% O ₂) (Max)	0,085 %	0,085 %	0,094 %	0,094 %
Average CONTENT of CO (13% O ₂) (Max)	1062 mg/Nm ³	1062 mg/Nm ³	1167 mg/Nm ³	1167 mg/Nm ³
OGC EMISSIONS (13% O ₂) (Max)	64 mg/Nm ³	64 mg/Nm ³	69 mg/Nm ³	69 mg/Nm ³
NOX EMISSIONS (13% O ₂) (Max)	90 mg/Nm ³	90 mg/Nm ³	85 mg/Nm ³	85 mg/Nm ³
DUST CONTENT (13% O ₂)	21 mg/Nm ³	21 mg/Nm ³	20 mg/Nm ³	20 mg/Nm ³
FLUE NEGATIVE PRESSURE (Max)	12 Pa	12 Pa	12 Pa	12 Pa
FLUE GAS EXHAUST DIAMETER	140 mm	140 mm	140 mm	140 mm
MANDATORY DAMPER	NO	NO	NO	NO
FUEL	WOOD	WOOD	WOOD	WOOD
WOOD MOISTURE CONTENT (Max)	13,3 %	13,3 %	13,3 %	13,3 %
LOG LENGTH	30 cm	30 cm	33 cm	33 cm
LOG WEIGHT	1,8 kg	1,8 kg	2,1 kg	2,1 kg
HEATABLE VOLUME 18/20°C Coeff. 0.045 kW (Max)	156 m ³	156 m ³	180 m ³	180 m ³
HEARTH VOLUME	16,6 dm ³	16,6 dm ³	19,2 dm ³	19,2 dm ³
HEARTH INLET	2,3 dm ³	2,3 dm ³	2,9 dm ³	2,9 dm ³
HEARTH INLET DIMENSIONS (WxH)	15x15 cm	15x15 cm	17,2x16,7 cm	17,2x16,7 cm
HEARTH DIMENSIONS (WxDxH)	17,4x41,5x23 cm	17,4x41,5x23 cm	21,5x41,5x21,5 cm	21,5x41,5x21,5 cm
OVEN DIMENSIONS (WxDxH)	24x42x29 cm	24x42x29 cm	33x42x29 cm	33x42x29 cm
ASH PAN CAPACITY	4,9 dm ³	4,9 dm ³	5,6 dm ³	5,6 dm ³
ROTATING HEARTH GRILLE	YES	YES	YES	YES
ADJUSTABLE PRIMARY AIR	YES	YES	YES	YES
ADJUSTABLE SECONDARY AIR	YES	YES	YES	YES
VENTILATION	NO	NO	NO	NO
POWER SUPPLY	-	-	-	-
ABSORBED POWER (Max)	-	-	-	-
EXTERNAL AIR VENT (CROSS-SECTION) (Min)	100 cm ²	100 cm ²	100 cm ²	100 cm ²
EXTERNAL COMBUSTION AIR CONNECTION PIPE DIAMETER (MAXIMUM LENGTH 2 m)	80 mm	80 mm	80 mm	80 mm
DISTANCE FROM COMBUSTIBLE MATERIAL (back/side/bottom)	40 / 20 / 0 mm	40 / 20 / 0 mm	40 / 2,5 / 0 mm	40 / 2,5 / 0 mm
DISTANCE FROM COMBUSTIBLE MATERIAL (ceiling/front)	750 / 1000 mm	750 / 1000 mm	750 / 1000 mm	750 / 1000 mm

DESCRIPTION	SMART 60V	SMART 60VS	SMART 80V	SMART 80VS
WIDTH	59,5 cm	59,5 cm	79,5 cm	79,5 cm
DEPTH	60 cm	60 cm	60 cm	60 cm
HEIGHT	86 cm	86 cm	86 cm	86 cm
WEIGHT	123 kg	123 kg	152 kg	152 kg
NOMINAL HEAT OUTPUT (Max)	6,5 kW	6,5 kW	7,5 kW	7,5 kW
THERMAL EFFICIENCY (Max)	85,1 %	85,1 %	85,5 %	85,5 %
FLUE GAS TEMPERATURE (Max)	185 °C	185 °C	179 °C	179 °C
MAXIMUM FLUE GAS FLOW RATE (Max)	6,3 g/s	6,3 g/s	7,1 g/s	7,1 g/s
CO EMISSIONS (13% O ₂) (Max)	0,085 %	0,085 %	0,094 %	0,094 %
Average CONTENT of CO (13% O ₂) (Max)	1062 mg/Nm ³	1062 mg/Nm ³	1167 mg/Nm ³	1167 mg/Nm ³
OGC EMISSIONS (13% O ₂) (Max)	64 mg/Nm ³	64 mg/Nm ³	69 mg/Nm ³	69 mg/Nm ³
NOX EMISSIONS (13% O ₂) (Max)	90 mg/Nm ³	90 mg/Nm ³	85 mg/Nm ³	85 mg/Nm ³
DUST CONTENT (13% O ₂)	21 mg/Nm ³	21 mg/Nm ³	20 mg/Nm ³	20 mg/Nm ³
FLUE NEGATIVE PRESSURE (Max)	12 Pa	12 Pa	12 Pa	12 Pa
FLUE GAS EXHAUST DIAMETER	140 mm	140 mm	140 mm	140 mm
MANDATORY DAMPER	NO	NO	NO	NO
FUEL	WOOD	WOOD	WOOD	WOOD
WOOD MOISTURE CONTENT (Max)	13,3 %	13,3 %	13,3 %	13,3 %
LOG LENGTH	30 cm	30 cm	33 cm	33 cm
LOG WEIGHT	1,8 kg	1,8 kg	2,1 kg	2,1 kg
HEATABLE VOLUME 18/20°C Coeff. 0.045 kW (Max)	156 m ³	156 m ³	180 m ³	180 m ³
HEARTH VOLUME	16,6 dm ³	16,6 dm ³	19,2 dm ³	19,2 dm ³
HEARTH INLET	2,3 dm ³	2,3 dm ³	2,9 dm ³	2,9 dm ³
HEARTH INLET DIMENSIONS (WxH)	15x15 cm	15x15 cm	17,2x16,7 cm	17,2x16,7 cm
HEARTH DIMENSIONS (WxDxH)	17,4x41,5x23 cm	17,4x41,5x23 cm	21,5x41,5x21,5 cm	21,5x41,5x21,5 cm
OVEN DIMENSIONS (WxDxH)	24x42x29 cm	24x42x29 cm	33x42x29 cm	33x42x29 cm
ASH PAN CAPACITY	4,9 dm ³	4,9 dm ³	5,6 dm ³	5,6 dm ³
ROTATING HEARTH GRILLE	YES	YES	YES	YES
ADJUSTABLE PRIMARY AIR	YES	YES	YES	YES
ADJUSTABLE SECONDARY AIR	YES	YES	YES	YES
VENTILATION	YES	YES	YES	YES
POWER SUPPLY	230V - 50Hz	230V - 50Hz	230V - 50Hz	230V - 50Hz
ABSORBED POWER (Max)	50 W	50 W	50 W	50 W
EXTERNAL AIR VENT (CROSS-SECTION) (Min)	100 cm ²	100 cm ²	100 cm ²	100 cm ²
EXTERNAL COMBUSTION AIR CONNECTION PIPE DIAMETER (MAXIMUM LENGTH 2 m)	80 mm	80 mm	80 mm	80 mm
DISTANCE FROM COMBUSTIBLE MATERIAL (back/side/bottom)	40 / 20 / 0 mm	40 / 20 / 0 mm	40 / 2,5 / 0 mm	40 / 2,5 / 0 mm
DISTANCE FROM COMBUSTIBLE MATERIAL (ceiling/front)	750 / 1000 mm	750 / 1000 mm	750 / 1000 mm	750 / 1000 mm



89023007B

Rev. 00-2024

CADEL srl
31025 S. Lucia di Piave - TV
Via Martiri della Libertà, 74 - Italy
Tel. +39 0438 1520200

www.cadelsrl.com
www.free-point.it