

# **USER MANUAL**

Wood Cooking Stove







©2023 CADEL srl | All rights reserved - Tutti i diritti riservati

**KOOK 60 - KOOK 80- KOOK 90**  
**SMART 60 - SMART 80 - FRIDA 80**

## SUMMARY

<b>1</b>	<b>MANUAL SIMBOLOGY.....</b>	<b>3</b>
<b>2</b>	<b>DEAR CUSTOMER .....</b>	<b>3</b>
<b>3</b>	<b>CAUTIONS .....</b>	<b>4</b>
3.1	REVISIONS TO THE PUBLICATION .....	4
3.2	CARE OF THE MANUAL AND HOW TO CONSULT IT ...	4
<b>4</b>	<b>SAFETY REQUIREMENTS .....</b>	<b>5</b>
<b>5</b>	<b>CAUTIONS - WARRANTY CONDITIONS.....</b>	<b>5</b>
5.1	INFORMATION.....	5
5.2	WARRANTY CONDITIONS.....	6
<b>6</b>	<b>SPARE PARTS .....</b>	<b>7</b>
<b>7</b>	<b>DISPOSAL OF MATERIALS .....</b>	<b>7</b>
7.1	WARNINGS FOR THE CORRECT DISPOSAL OF THE PRODUCT .....	7
7.2	INFORMATION FOR MANAGEMENT OF ELECTRIC AND ELECTRONIC APPLIANCE WASTE CONTAINING BATTERIES OR ACCUMULATORS .....	8
7.3	INSTRUCTIONS FOR PACKAGING DISPOSAL.....	8
<b>8</b>	<b>USE .....</b>	<b>9</b>
8.1	INTRODUCTION .....	9
8.2	IGNITION .....	10
8.3	STOVE REFILLING .....	12
8.4	BAKING .....	12
8.5	HOODED TOP .....	13
8.6	OPTIONAL FANS AND LIGHT.....	13
8.7	ADVERSE WEATHER CONDITIONS .....	13
8.8	CREOSOTE DANGER .....	13
8.9	FIRE EXTINGUISHING IN CASE OF FIRE.....	14
8.10	FLUE GAS PASS PROBLEMS KOOK 60 - SMART 60 (KOOK 67-KOOK 70) .....	14
8.11	FLUE GAS PASS PROBLEMS (KOOK 80 - KOOK 90 - SMART 80) .....	14
<b>9</b>	<b>FUEL.....</b>	<b>15</b>
<b>10</b>	<b>ROUTINE MAINTENANCE .....</b>	<b>15</b>
10.1	INTRODUCTION .....	15
10.2	BURNING POT AND ASH TRAY CLEANING .....	16
10.3	FUME PIPES ANNUAL CLEANING .....	16
10.4	CLEANING UNDER THE STOVE .....	16
10.5	GENERAL CLEANING.....	17
10.6	CLEANING OF PAINTED METAL PANELS .....	17
10.7	CLEANING OF CERAMIC PANELS.....	17
10.8	GLASS CLEANING .....	17
10.9	OVEN CLEANING.....	17
10.10	COOKTOP CLEANING .....	17
10.11	CLEANING THE STAINLESS STEEL FINISHES .....	17
<b>11</b>	<b>IN CASE OF ANOMALY.....</b>	<b>18</b>
11.1	PROBLEM SOLVING .....	18
<b>12</b>	<b>TECHNICAL DOCUMENTATION FOR LOCAL SPACE HEATERS ACCORDING TO COMMISSION REGULATIONS (EU) 2015/1185 - (EU) 2015/1186 (PRODUCT FICHE) .....</b>	<b>20</b>

## 1 MANUAL SIMBOLOGY

	<b>USER</b>
	<b>AUTHORISED TECHNICIAN</b> <b>(ONLY to interpret or the Stove-manufacturer or the Authorized Technician of Technical Assistance Service approved by the Stove-manufacturer)</b>
	<b>SPECIALIZED STOVE-REPAIRER</b>
	<b>CAUTION:</b> <b>READ CAREFULLY THE NOTE</b>
	<b>CAUTION:</b> <b>DANGER OR IRREVERSIBLE DAMAGE POSSIBILITY</b>

- The icons with the stylized figures indicates whom the subject dealt in the paragraph is addressed to (between the User and/or the Authorized Technician and/or the Specialized Stove-repairer).
- WARNING symbols indicates an important note.

## 2 DEAR CUSTOMER

Dear Customer,

Our products are designed and manufactured in accordance with standards in force, with high quality materials and using our extensive experience in the transformation processes.

To get the best performance, we suggest you read the instructions in this manual carefully.

This installation guide is an integral part of the product: ensure that the manual is always supplied with the appliance, even if it changes owner. If the manual is lost, you can request another copy from the local Technical Dept. or download it directly from the company's website.

All local regulations, including those referring to national and European standards, must be observed when installing the appliance.

In Italy, for the installation of systems with a biomass below 35KW, refer to the Ministerial Decree 37/08 and the qualified installation technician with the suitable requirements must issue a certificate of compliance for the system installed. (By system we intend Stove+Flue+Air inlet).

Our solid bio-combustible products, (hereinafter called "Products") are designed and manufactured in compliance with one of the following European standard harmonised to Regulation (UE) no. 305/2011 for construction products:

**EN 14785:** "Residential space heating appliances fired by wood pellets"

**EN 13240:** "Room heaters fired by solid fuel."

**EN 13229:** "Inset appliances including open fires fired by solid fuels"

**EN 12815:** "Residential cookers fired by solid fuel"

The products also comply with the essential requirements of Directive **2009/125/EC (Eco Design)** and, where applicable, Directives:

According to (EU) No. 305/2011 regulation, the "Declaration of Performance" and "Declaration of Conformity" are available online, in the download area, at the web sites:

- [www.cadelsrl.com](http://www.cadelsrl.com)

- [www.free-point.it](http://www.free-point.it)

- [www.pegasoheating.com](http://www.pegasoheating.com)

Having specified the above, we highlight and report that:

- **This manual and technical data sheet, also available on our website**, bear all of the specific indications and necessary and essential information to choose the product, to install it correctly and to properly size the smoke expulsion system;
- **the Products must be installed, controlled and serviced by a qualified operator**, according to the instructions in this manual and in compliance with the laws and installation and maintenance standards in force in individual countries, so as to provide an efficient heating system, properly sized according to the needs of the home.

## 3 CAUTIONS

- All the pictures carried in this manual are only for indicative and explanatory purpose and could therefore slightly differ from your appliance.
- The referring appliance is those you purchased.
- In case of doubts or difficulties in the comprehension or for problems not described in this manual, please promptly contact your distributor or installer.

### 3.1 REVISIONS TO THE PUBLICATION

The content of this manual is strictly technical and the property of CADEL S.r.l.

No part of this manual may be translated into other languages, adapted and/or reproduced, even in part, in other mechanical and/or electronic form or media, for photocopies, recordings or other, without the prior written authorisation of CADEL S.r.l.

The company reserves the right to make changes to the product at any time without prior notice. The owner company reserves its rights according to law.

### 3.2 CARE OF THE MANUAL AND HOW TO CONSULT IT

- Take care of this manual and store it in an easily and quickly accessible place.
- Should this manual be lost or destroyed, request a copy from your retailer or directly from the authorised Technical assistance department. It can also be downloaded from the company's website.
- **"Bold text"** requires special attention.

## 4



## SAFETY REQUIREMENTS



- Packaging are not toys and could cause suffocation or strangulation and other health hazards! People (children included) with reduced mobility, psychological diseases or without experience and knowledge must be kept away from packaging. The stove is not a toy.
- Please check with your local authorities if exists any restrictive regulation which regards the combustible air inlet, the fumes exhaust system, the chimney flue and the chimney pot.
- The company declines any responsibility regarding the bad running of the stove if it is due to the use of a no correctly dimensioned chimney flue which does not respect current regulations.
- It is forbidden to use any type of liquid combustible!
- It is forbidden to burn wood processing waste containing glue or paint, waste in general and cardboard!
- Intallation, electric connection, operation test and maintenance must be carried out by an authorized and skilled technician.
- This appliance must not be used by people (children included) with reduced mobility, psychological diseases or without experience and knowledge except in case of supervision or instruction about the use of the appliance by people responsible for their safety.
- Children must be constantly overseen in order to assure that they do not play with the appliance.
- Do not use flammable liquids during the ignition (alcohol, petrol, oil, etc...).
- Do not subject the cast iron cooktop to too high temperature (cherry red) because there is the risk of breakage!
- During stove refilling do not wear flammable or large clothing.
- Do not open and close the fire door violently: the glass can brake!
- During regular working is dangerous to keep open the ash drawer and/or the fire box to increase air draught! There are appropriate instruments to adjust combustion air (primary air valve, register, etc...).
- Before any movement let the fire inside the combustion chamber extinguish till the total cooling and always disconnect the plug from the socket (if there are).
- **During its running, the stove reaches high temperatures! Keep away children and animals and for your safety please use appropriate fireproof devices, such as heatprotecting gloves.**



Fig. 1 - Attention: hot surfaces!

## 5 CAUTIONS - WARRANTY CONDITIONS

### 5.1 INFORMATION

- Please contact the retailer or qualified personnel for any information, problem or malfunction.
- Only use the fuel specified by the manufacturer.
- When the product is switched on for the first time, it is normal for it to emit smoke due to the paint heating up for the first time. Therefore make sure the room it is installed in is well-ventilated.
- Periodically check and empty the inspectionable parts of the smoke duct (e.g. Tee fitting caps)
- Have the smoke outlet system periodically checked and cleaned

- Store this installation and user manual with care as it must accompany the product for the duration of its useful life. If the product is sold or transferred to another user, always ensure the manual is also handed over.

## 5.2 WARRANTY CONDITIONS

The duration, conditions and limitations of CADEL S.r.l. can be found on the guarantee card enclosed with the device.

The company guarantees the product, **with the exception of elements subject to normal wear** listed below, for a period of **2 (two) years** from the date of purchase attested by:

- a document to serve as proof of purchase (invoice and/or receipt) that shows the name of the vendor and the date on which the purchase was made;
- forwarding of the completed certificate of guarantee within 8 days of purchase.

Furthermore, the product must be installed and started by specialised personnel who must, where provided, issue a declaration of conformity of the plant and of the proper functioning of the product, for the warranty to be valid and effective.

We recommend testing the product before completion with the relative finishes (claddings, painting of walls, etc.).

Installations not meeting the current standards, improper use and lack of maintenance as expected by the manufacturer, void the product warranty.

The guarantee is valid on the condition that the instructions and warnings contained in the use and maintenance manual are observed, and therefore the product is used correctly.

The replacement of the entire system or the repair of one of its components does not extend the guarantee period, and the original expiry date remains unchanged.

The guarantee covers the replacement or free repair **of parts recognised as being faulty at source due to manufacturing defects**.

To benefit from the guarantee, in the event of a fault, the customer must have the guarantee certificate and present it with the proof of purchase document to the Technical Assistance Office.

**The guarantee does not cover malfunctions and/or damage to the appliance that arise due to the following causes:**

- Damage caused during transportation or relocation.
- All parts that develop faults due to negligence or improper use, incorrect maintenance, installation that does not comply with the manufacturer's instructions (always refer to the installation and use manual provided with the appliance).
- Incorrect dimensioning with regards to the use or faults in the installation or failure to adopt the necessary devices to guarantee proper execution.
- Improper overheating of the equipment, use of fuels not conforming to the types and quantities indicated in the instructions provided.
- Further damage caused by incorrect user interventions in an attempt to fix the initial fault.
- Worsening of the damage due to the continued use of the equipment by the user, once the defect has been noticed.
- In the presence of a boiler, any corrosions, incrustations or breaks caused by water flow, condensation, hardness or acidity of the water, improperly performed descaling treatments, lack of water, mud or limescale deposits.
- Inefficiency of chimneys, flues or parts of the plant affecting the equipment.
- Damage caused by tampering with the appliance, atmospheric agents, natural disasters, vandalism, electrical discharges, fires, faults in the electric and/or hydraulic system.
- Failure to have the stove cleaned on an annual basis by an authorised technician or qualified personnel will result in the loss of the warranty.

Also excluded from this guarantee are:

- Parts subject to normal wear such as gaskets, glass, claddings and cast iron grids, painted, chrome-plated or gilded parts, handles and electric cables, bulbs, indicator lights, knobs, all parts which can be removed from the hearth.
- Variations in colour of the painted or ceramic/serpentine parts and craquelure ceramics as they are natural characteristics of the material and product use.
- Masonry work.
- Plant parts (if present) not supplied by the manufacturer.

Any technical interventions on the product to eliminate the above-said defects and consequent damages must be agreed upon with the Technical Assistance Centre, who reserves the right to accept the relative appointment or not. However, said interventions will not be carried out under warranty but as technical assistance to be granted at part of any eventual and specific agreed conditions and in accordance with the fee in force for the work to be carried out.

The user will also be charged for any costs incurred to remedy the incorrect technical interventions, tampering or damage to the appliance, not attributable to original faults.

Save for the legal or regulatory limits, the guarantee does not cover the containment of atmospheric and acoustic pollution.

**The company declines all liability for any damage which may be caused, directly or indirectly, to persons, animals or objects as a consequence of non compliance with any prescription specified in the manual, especially warnings regarding installation, use and maintenance of the appliance.**

## 6 SPARE PARTS

For each repair or adjustment which should be necessary, please contact the dealer where you purchased your stove or your nearest Technical Assistance Service, specifying:

- Appliance model
- Serial number
- Type of problem

Use only original spare parts which you can find at our Technical Assistance Services.

## 7 DISPOSAL OF MATERIALS

### 7.1 WARNINGS FOR THE CORRECT DISPOSAL OF THE PRODUCT

The owner is the sole party responsible for demolishing and disposing of the product. This must be performed in compliance with laws related to safety and environmental protection in force in his/her country.

At the end of its working life, the product must not be disposed of as urban waste.

It must be taken to a special differentiated waste collection centre set up by the local authorities or to a retailer that provides this service.

Separating and recycling prevents potential negative effects on the environment and health (often caused by inappropriately disposing of product parts). It also allows materials to be recovered in order to obtain significant savings in energy and resources.

The following table and the exploded view it refers to highlight the main components that can be found in the device and indications on how to separate and dispose of them correctly when no longer used.

More specifically, the electric and electronic components must be separated and disposed of in authorised centres, in compliance with the WEEE directive 2012/19/EU and the relative national transpositions.

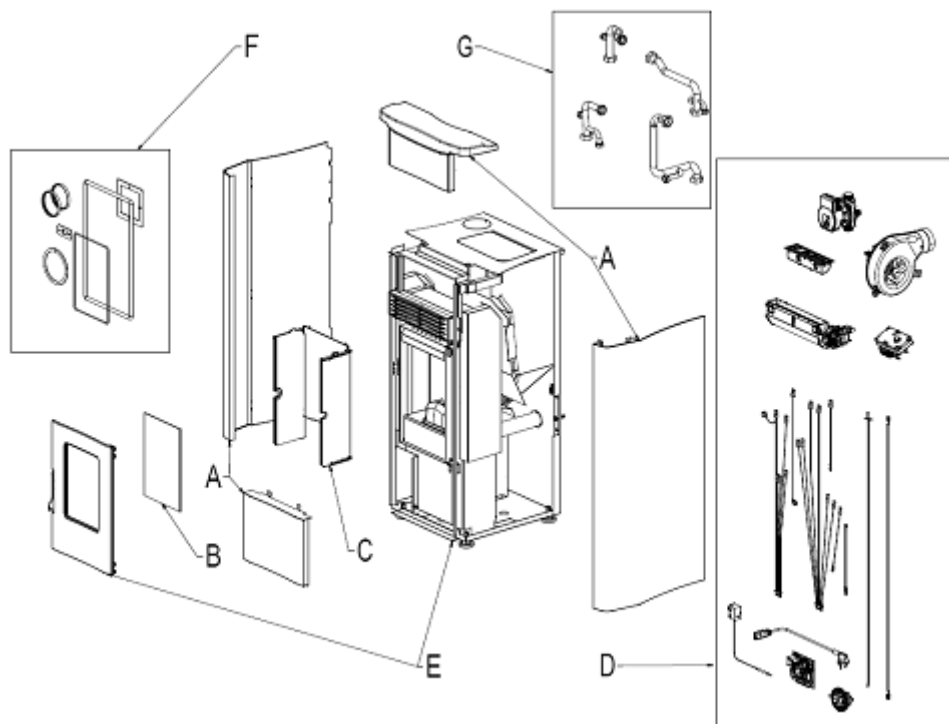

**Fig. 2 - Exploded drawing**

LEGENDA	WHERE TO DISPOSE	MATERIALS
A. OUTER CLADDING	If there is any, to be disposed of separately based on the material used:	Metal
		Glass
		Tiles or ceramics
		Stone
B. GLASS DOORS	If there is any, to be disposed of separately based on the material used:	Glass ceramic (fire door): to be disposed of with inert or mixed waste
		Tempered glass (oven door): to be disposed of with glass
C. INTERIOR CLADDING	If there is any, to be disposed of separately based on the material used:	Metal
		Refractory materials
		Insulating panels
		Vermiculite
		Insulation, vermiculite and refractory materials that have come into contact with flames or exhaust gases (dispose of in mixed waste)
D. ELECTRIC AND ELECTRONIC COMPONENTS	To be disposed of separately in authorised centres, as indicated in the WEEE directive 2012/19/EU and the relative national transposition.	Wiring, motors, fans, circulators, display panels, sensors ignition plug, electronic cards, batteries.
E. METAL STRUCTURE	To be disposed of separately with metal	-
F. COMPONENTS THAT CANNOT BE RECYCLED	To be disposed of with mixed waste	E.G.: Gaskets, rube piping, silicone or fibres, plastic.
G. HYDRAULIC COMPONENTS	Piping, fittings, expansion vessel, valves. If there are any, to be disposed of separately based on the material they are made of:	Copper
		Brass
		Stainless steel
		Other materials

## 7.2 INFORMATION FOR MANAGEMENT OF ELECTRIC AND ELECTRONIC APPLIANCE WASTE CONTAINING BATTERIES OR ACCUMULATORS

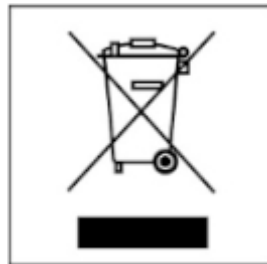

Fig. 3 - Waste disposal

This symbol, which is used on the product, batteries, accumulators or on the packaging or documents, means that at the end of its useful life, this product, the batteries and the accumulators included must not be collected, recycled or disposed of together with domestic waste.

Improper management of electric or electronic waste or batteries or accumulators can lead to the leakage of hazardous substances contained in the product. For the purpose of preventing damage to health or the environment, users are kindly asked to separate this equipment and/or batteries or accumulators included from other types of waste and to arrange for disposal by the municipal waste service. It is possible to ask your local dealer to collect the waste electric or electronic appliance under the conditions and following the methods provided by national laws transposing the Directive 2012/19/EU.

Separate waste collection and recycling of unused electric and electronic equipment, batteries and accumulators helps to save natural resources and to guarantee that this waste is processed in a manner that is safe for health and the environment.







For more information about how to collect electric and electronic equipment and appliances, batteries and accumulators, please contact your local Council or Public Authority competent to issue the relevant permits.

## 7.3 INSTRUCTIONS FOR PACKAGING DISPOSAL

The material that the appliance's packaging is made of must be managed correctly, in order to make collection, reuse, recovery and recycling easier, where possible.

The table below illustrates the possible components that the packaging is made of, and the relative instructions for correct disposal.

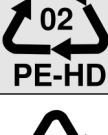
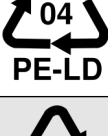

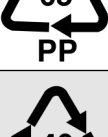
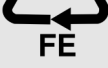
DESCRIPTION	CODE MATERIAL	SYMBOL	DIRECTIONS FOR COLLECTION
- WOOD BED - WOOD CAGE - WOOD PALLET	WOOD FOR 50		SORTED waste collection WOOD Check with the competent body on how to dispose of this packaging at the recycling depot
- CARDBOARD BOX - CARDBOARD CORNER - CARDBOARD SHEET	CORRUGATED CARDBOARD PAP 20		SORTED waste collection PAPER Check the instructions of the competent body
- CARDBOARD CORNER	NOT CORRUGATED CARDBOARD PAP 21		SORTED waste collection PAPER Check the instructions of the competent body
- LABELS - INSTRUCTION MANUAL	PAPER PAP 22		SORTED waste collection PAPER Check the instructions of the competent body
- APPLIANCE BAG	POLYETHYLENE HD-PE 2		SORTED waste collection PLASTIC Check the instructions of the competent body
- APPLIANCE BAG - BAG OF ACCESSORIES - BUBBLE WRAP - PROTECTIVE SHEET - LABELS	POLYETHYLENE LD PE 04		SORTED waste collection PLASTIC Check the instructions of the competent body
- POLYSTYRENE - FOAM PEANUTS	POLYSTYRENE PS 6		SORTED waste collection PLASTIC Check the instructions of the competent body
- STRAP - TAPE	POLYPROPYLENE PP 5		SORTED waste collection PLASTIC Check the instructions of the competent body.
- SCREWS - STAPLES FOR STRAP - FASTENING BRACKET	IRON FE 40		SORTED waste collection METAL Check with the competent body on how to dispose of this packaging at the recycling depot

## 8 USE

### 8.1 INTRODUCTION

To have the best performance with the lowest consumption please follow the here described instructions.

- Wood ignition occurs very easily if the installation is correct and if the chimney flue is efficient.
- By first ignition of the stove hold a slow fire for at least 4-5 hours in order to allow the material of which the heater and the hearth are made up of to adjust the inner mechanical stresses. This operation must be executed at least 3-4 times a year.
- Plant fat waste and varnishes can release bad smells and smoke during first working hours: it is advisable to ventilate the room because they can be noxious to people and animals.
- If inside the combustion chamber there are booklets, manuals, etc..., remove them.
- Check that the plug is inserted in the power socket (this only applies to forced ventilation stoves).

## 8.2 IGNITION

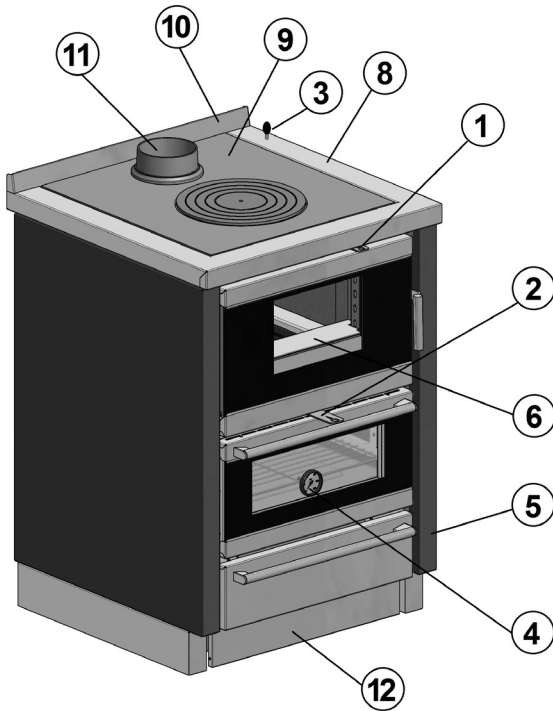

Fig. 4 - Kook 60 4.0 - Kook 70 4.0 - Smart 60

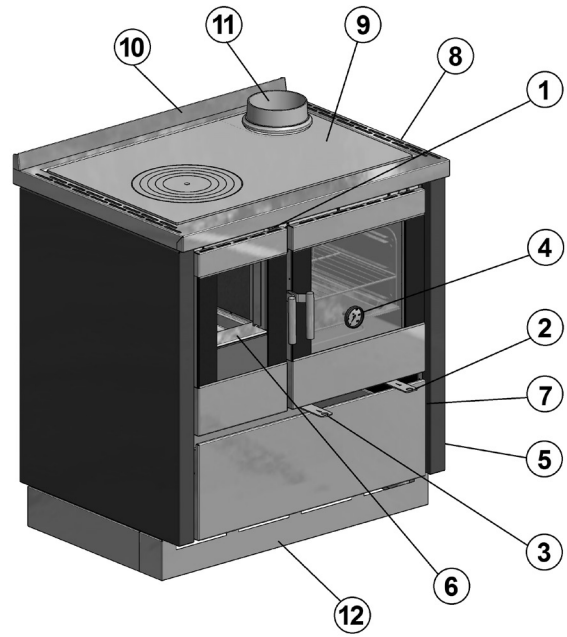

Fig. 5 - Kook 80 - Kook 87 - Kook 90 4.0 - Smart 80

LEGEND	Fig. 4 - Fig. 5
1	Secondary air regulator above door
2	Combustion air regulator
3	Ignition valve
4	Oven thermostat
5	Cooker side panel
6	Combustion chamber
7	Fan switch
8	Stainless steel top
9	Hot plate
10	Backplash
11	Exhaust stub pipe
12	Stainless steel plinth

- Place firelighters in the burning pot with small pieces of well-seasoned wood.
- Light and if necessary keep the door open for a few minutes until the combustion chamber and flue start to heat up.

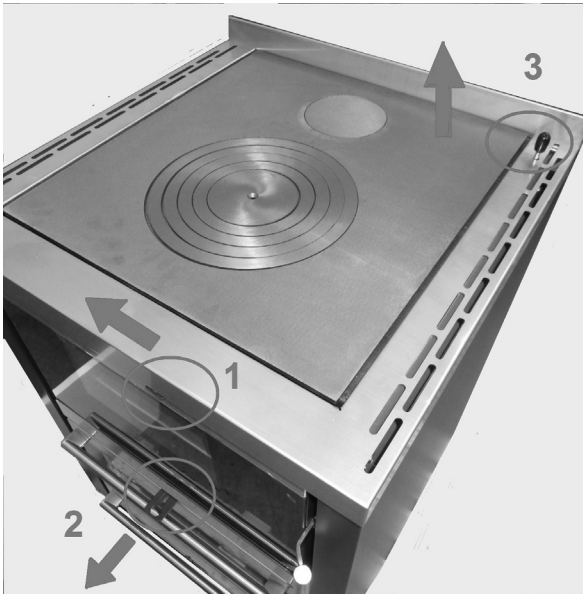

Fig. 6 - Wood arrangement



Fig. 7 - Wood ignition

- Open the regulator (1) above the door completely, the combustion air regulator (2) and the ignition valve (3).



**Fig. 8 - open registers**



**Fig. 9 - open registers**

- As the fire lights gradually add small pieces of well-seasoned wood.
- When the flue is hot enough, close the ignition valve **(3)** and the regulator **(1)** above the door.



**Fig. 10 - closed registers**



**Fig. 11 - closed registers**

- Load the stove when embers have formed in the combustion chamber.
- Load a well-seasoned log **Fig. 13** with the size and weight specified in INSTALLER MANUAL.
- Adjust the combustion air regulator **(2)**.
- Once it is closed, the ignition valve **(3)** forces the hot combustion gas under the hot plate and around the inside of the oven, to the benefit of oven heating and greater radiant heat output of the cooker.



Fig. 12 - Bed of embers



Fig. 13 - Log on embers

### 8.3 STOVE REFILLING

Load the stove when embers have formed in the combustion chamber.

- Open the ignition valve (1).
- Open the stove door slowly.
- Using the poker, break the burnt log and form a bed of embers.
- Place a well-seasoned log in the centre of the embers and close the door (see previous photos).
- Close the ignition valve (1).



*Open the fire door with naked flames can be dangerous for user and/or home.*



*When you put a log on embers that have almost gone out, smoke may accumulate and form an explosive gas. In extreme cases an explosion may occur. We recommend starting the fire again with small sticks of wood.*



*During operation some external parts can reach high temperatures. During refilling phases use proper protection gloves.*

To achieve the nominal output values, place a well-seasoned beech log in the centre of the embers, with the size and weight specified in INSTALLER MANUAL.

Close half the regulator (2). The stove operating time is approximately 45/60 minutes. When combustion has ended, load the stove again.

It is prohibited to load amounts of wood exceeding those specified.

Excessive amounts of wood may damage the hearth and the structure of the stove.

The manufacturer disclaims any liability for damage caused by excessive loading or for use of fuel that does not comply with the specifications.

### 8.4 BAKING

When the stove has been working, close the start-up valve (3) and wait till the oven reaches the needed temperature.

We remind that the oven temperature is proportional to burning rate and needs a constant burning on order to avoid temperature leaps inside the oven.

Stove's ovens are endowed with a thermometer which checks the temperature in the position they are installed in. To have the real temperature in the inner of the oven the datas need to be increased of 20°C.

- KOOK 60-67-70 oven temperature: max 200°C with fully open register (2).
- SMART 60 oven temperature: max 240°C with fully open register (2).
- KOOK 80-87-90 + SMART 80 oven temperature: max 260°C with fully open register (2).



Fig. 14 - Oven thermometer

THERMOMETER POSITION	CAKE	ROAST MEET	BREAD
OVEN INNER TEMPERATURES	115 °C	180 °C	240 °C

### 8.5 HOODED TOP

By request some models are endowed with a hooded top which must not ever be placed on the still hot cooktop because of overheating. Once placed the hooded top, the kitchen becomes a worktop. Pay attention not to scratch it by moving pans and pots.

### 8.6 OPTIONAL FANS AND LIGHT

Some models are supplied with the optional fans and light.

FANS: these turn on and off automatically. If there is a need to deactivate them, it is possible to switch them off by pressing the button located inside the wood drawer (see Fig. 15 and Fig. 16).

LIGHT: to turn the light on and off, press the relative button located inside the wood drawer (see Fig. 15 and Fig. 16).



Fig. 15 - Switch position



Fig. 16 - Switches

### 8.7 ADVERSE WEATHER CONDITIONS

When the external temperatures are severe and/or there are adverse weather conditions (strong wind), the chimney is subjected to a lack in draught thus impeding a correct fume expulsion.

- Fill the heart with few wood logs and keep air register valves opened completely.

### 8.8 CREOSOTE DANGER



*The use of humid and/or bad quality wood (for example resinous wood) cause creation of creosote along the chimney flue obstructing fume passages.*



*The creosote is flammable and if amassed over the time it must be removed in order to prevent the risk of fire of the chimney flue.*

## 8.9 FIRE EXTINGUISHING IN CASE OF FIRE

- In the event of fire, close the air regulating valve and call the fire brigade immediately.
- Never use water to put out the fire inside the combustion chamber.
- Use an extinguisher and call the fire brigade immediately.
- When the fire has stopped burning, have the flue inspected by a specialised heating engineer.

## 8.10 FLUE GAS PASS PROBLEMS KOOK 60 - SMART 60 (KOOK 67-KOOK 70)

If there are draught issues (smoke and odour coming out of the cooker) after the ignition valve (3) has been closed, act as follows:

- Open the cleaning cap under the oven by undoing the two screws (8 mm spanner) (see **Fig. 17**).
- Using the poker, turn the valve under the oven by 90°, so that the flue gas path is shortened (see **Fig. 18**).



**Fig. 17 - Remove the screws**



**Fig. 18 - Turn the valve**

## 8.11 FLUE GAS PASS PROBLEMS (KOOK 80 - KOOK 90 - SMART 80)

If there are draught issues (smoke and odour coming out of the cooker) after the ignition valve (3) has been closed, act as follows:

- Open the cleaning cap under the oven by undoing the two screws (8 mm spanner) (see **Fig. 19**).
- Using the poker, turn the valve under the oven by 90°, so that the flue gas path is shortened (see **Fig. 20**).



**Fig. 19 - Remove the screws**



**Fig. 20 - Turn the valve**

- Turn the cast iron hot plate and remove the deflector under the hot plate (see **Fig. 21 e Fig. 22**).

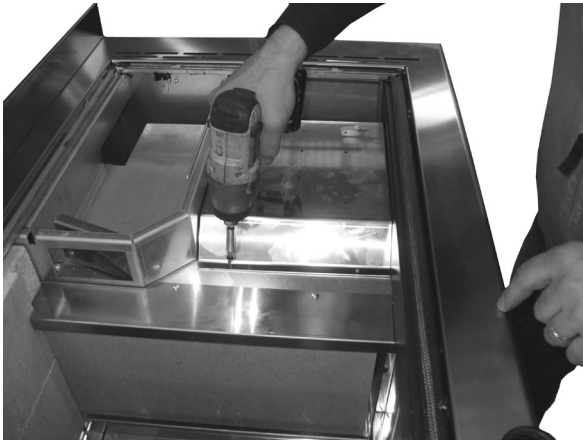

Fig. 21 - Remove the screws

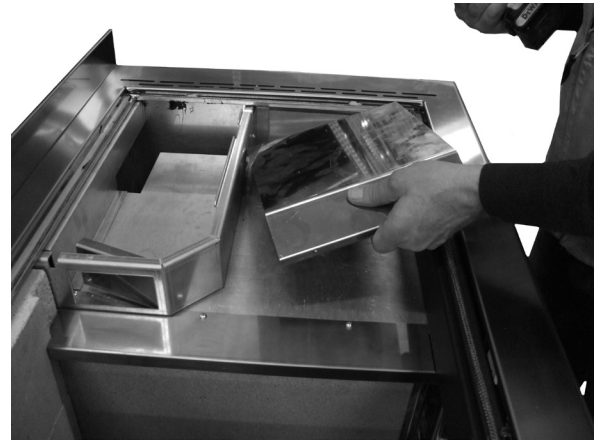

Fig. 22 - Remove the deflector

## 9 FUEL

- The allowed fuel is firewood and its derivatives (lignite blocks, compressed sawdust, etc.) with a maximum water content of 20%.
- To obtain good firewood, it must be seasoned outside for at least 2 years in a place protected from the weather.
- If the wood is purchased it must fulfil standard UNI-EN-14961-2 namely UNI EN ISO 17225-2 (class A1).



*Using damp wood or scraps of bark results in the formation of creosote in the ducts and in the hearth. The heat output of damp wood is much lower than the heat output of dry wood and pollutes a lot more.*

- To know the length of wood log to use, check the dimensions of stove combustion chamber.
- Here following some information about the quality of different type of woods:

TYPE OF WOOD	QUALITY	% PERFORMANCE
Oak	Excellent	100
Hornbeam	Excellent	100
Ash	Very good	92
Maple	Very good	91
Birch	Good	89
Elm	Good	84
Beech	Good	80
Willow	Sufficient	71
Spruce	Sufficient	70
Red deal	Fair	67
Larch	Fair	66
Lime	Worst	57
Poplar	Worst	50

## 10 ROUTINE MAINTENANCE

### 10.1 INTRODUCTION

For a long working life of the stove, have a periodic cleaning of the stove as described in the following paragraphs.

- Fume outlet pipes (fume conduit + chimney flue + chimney pot) must always be cleaned, scrubbed and checked by an authorized technician in compliance with local regulations, with the instructions of the manufacturer and those of your insurance company.
- If there are no local regulations and no instruction from your insurance company, it is necessary to have your fume pipe, chimney flue and chimney pot cleaned at least once a year.
- It is also necessary to have the combustion chamber, motors and fans cleaned and to have the gaskets and the electrical elements (if there are) checked at least once a year.



*All these operations must be planned in time with your Authorized Technical Assistance Service.*

- After a long ineffective time, before turning on the stove check if there are obstructions in the fume exhaust.
- If the stove had been using continuously and intensely, the whole system (chimney included), must be cleaned and checked more frequently.
- In case of replacement of damaged pieces please ask for the original spare part at the Authorized Retailer.

## 10.2 BURNING POT AND ASH TRAY CLEANING

For a good combustion, before of every stove ignition, remove the ash which has settled in the burning pot.

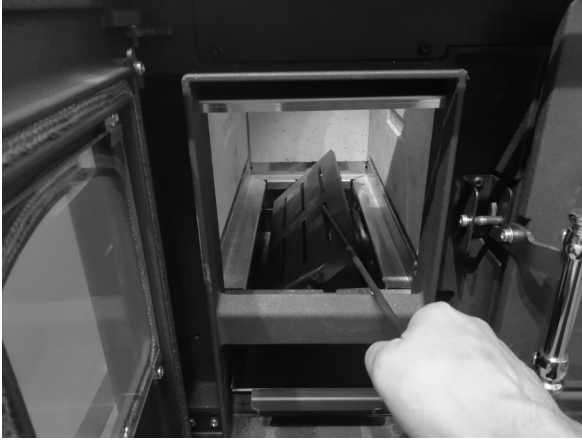

*Fig. 23 - Turn the grille*



*Fig. 24 - Remove the ash pan*

- Remove the ash from the burning pot by turning the cast iron grille using the poker (see **Fig. 23**).
- If full, the ash tray must be empty (see **Fig. 24**).
- Ash must be kept in a metal container with sealed cap, the same container must not ever be in contact with flammable materials (for example lent over a wooden floor), as ash inside keeps embers glowing for a long time.
- Only when the ash is completely extinguished can be thrown in the organic waste.
- Clean the ash also in the ash compartment.

## 10.3 FUME PIPES ANNUAL CLEANING

Clean once a week from soot with brushes.

The cleaning operation must be executed by a specialized stove-repairer who will provide for the cleaning of fume pipe, chimney flue and chimney pot. He will also check their efficiency and will release a written declaration of the safety of the appliance. This operation must be executed at least once a year. When it is not in use, we recommend disconnecting the appliance from the smoke duct. This avoids condensation from forming inside the combustion chamber.

## 10.4 CLEANING UNDER THE STOVE

To clean the floor under the cooker and/or maintenance, the wood storage drawer can be removed completely.

- Remove the draw and release the guide using your finger (see **Fig. 25** and **Fig. 26**).

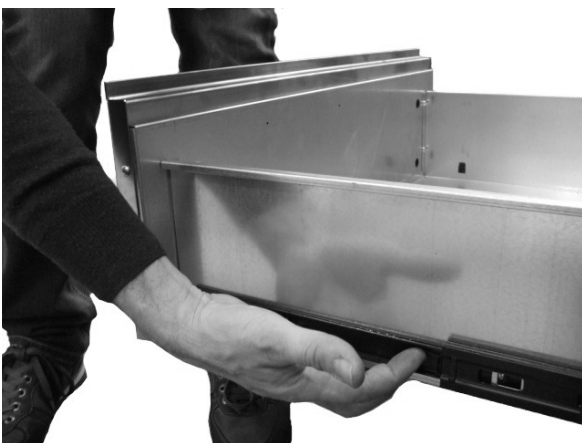

*Fig. 25 - Release the guide*



*Fig. 26 - Remove the draw*



## 10.5 GENERAL CLEANING

For cleaning external and inner parts of the stove do not use steel wools, muriatic acid or other corrosive and abrasive materials.

## 10.6 CLEANING OF PAINTED METAL PANELS

To clean painted metal panels use a soft cloth. Do not use degreasant agents like alcool, diluents, acetone, gasoline because these could irremediably damage the varnish.

## 10.7 CLEANING OF CERAMIC PANELS

Some stove models has an external lining made up of ceramic. These pieces are handmade therefore they could inevitably present crazings, seedinesses, shadings.

To clean ceramic panels use a soft and dry cloth. If using any cleaners this will seep through the crazings putting them in evidence.

## 10.8 GLASS CLEANING

The glass-ceramic of the fire door is able to stand till 700°C but not to thermal shocks. The probable cleaning with usual sale product for glass cleaning must be effected at cool glass in order to avoid explosions.

## 10.9 OVEN CLEANING

Clean the oven inner after every cooking by using a soft cloth with hot water or appropriate products.

Do not ever use a steel wool as they could irreparably damage the surfaces.

## 10.10 COOKTOP CLEANING

The cast iron plate has an oily protection on th surface which wears out over the time by the use. This could cause dark or rusty spots on the plate surface. To contrast this problem during log period of no use of the stove, clean the top with fine-graned emery cloth and then oil the surface with liquid paraffin.

## 10.11 CLEANING THE STAINLESS STEEL FINISHES

Due to the high temperatures, the shine of some stainless steel finishes of the stove door and/or stainless steel top may be altered (yellowish colour).

- Polish the stainless steel parts with specific products for stainless steel that can be purchased (see **Fig. 27**).













*Fig. 27 - Cleaning the stainless steel*





## 11 IN CASE OF ANOMALY

### 11.1 PROBLEM SOLVING



*In case of doubts regarding the use of the stove, please contact ALWAYS the Authorized Technician on order to avoid irreparable damages!*

PROBLEM	CAUSE	SOLUTION	INTERVENTO
Ignition difficulties	Too large wood	Use small and well dried wood logs during ignition, before bigger wood logs.	
	Too humid wood	Use well seasoned wood.	
	Lack of chimney draught	Open the registers completely. (If the problem persists, contact and expert stove repairer who will check the chimney flue efficiency).	
	Ambient without air recycling	Create immediately a ventilation grid.	
Creation of condensation	Large chimney flue section	Reduce the chimney flue section with thermal insulater pipes.	
	No insulated chimney flue	Cover the chimney flue with insulating material.	
	Too slow combustion	Open air registers in order to increase the fire and fume output temperature.	
Fume leakage from the heart	No insulated chimney flue	Cover the chimney flue with insulating material.	
	Adverse wheather conditions	No windproof chimney pot: have it replaced.	
	Too humid wood	Use well seasoned wood.	

PROBLEM	CAUSE	SOLUTION	INTERVENTO
The glass blackens excessively	Lack of chimney draught	Open the registers completely. (If the problem persists, contact and expert stove repairer who will check the chimney flue efficiency).	
	Too humid wood	Use well seasoned wood	
	Too slow combustion	Open air registers in order to increase the fire and fume output temperature.	
	Bad quality fuel	Use fuel described in <b>FUEL a pag. 15</b>	
Cooker overheating	Too much wood in the heart (red coloured plate or oven over 300°C)	Close all registers and open the oven door in order to have a faster cooling.	

## 12 TECHNICAL DOCUMENTATION FOR LOCAL SPACE HEATERS ACCORDING TO COMMISSION REGULATIONS (EU) 2015/1185 - (EU) 2015/1186 (PRODUCT FICHE)

Manufacturer	CADEL srl - Via Martiri delle Libertà 74 - 31025 Santa Lucia di Piave (TV) - Italy		
Trademark: model identifier	CADEL: SMART 60		
Description	Wood cooker stoves		
Indirect heating functionality	No		
Direct heat output	6,5 kW		
Indirect heat output	-		
CPR harmonised standard	EN 12815		
Notified body	IMQ Spa (N.B. 0051)		
Preferred fuel (unique)	Compressed wood with moisture content < 12 %	NO	
	Wood logs with moisture content ≤ 25 %	YES	
	Other woody biomass	NO	
$\eta_s$		75	%
EEL		113	-
Energy Efficiency Class (A++ to G scale)		A+	
Space heating emissions at nominal heat output	PM (al 13% O <sub>2</sub> )	21	mg/Nm <sup>3</sup>
	OGC (al 13% O <sub>2</sub> )	64	mg/Nm <sup>3</sup>
	CO (al 13% O <sub>2</sub> )	1062	mg/Nm <sup>3</sup>
	NO <sub>x</sub> (al 13% O <sub>2</sub> )	90	mg/Nm <sup>3</sup>
Space heating emissions at minimum heat output <i>Only required if correction factors F(2) or F(3) are applied</i>	PM (al 13% O <sub>2</sub> )	-	mg/Nm <sup>3</sup>
	OGC (al 13% O <sub>2</sub> )	-	mg/Nm <sup>3</sup>
	CO (al 13% O <sub>2</sub> )	-	mg/Nm <sup>3</sup>
	NO <sub>x</sub> (al 13% O <sub>2</sub> )	-	mg/Nm <sup>3</sup>
Heat output	Nominal heat output (P <sub>nom</sub> )	6.5	kW
	Minimum heat output (indicative) (P <sub>min</sub> )	-	kW
Useful efficiency (NCV as received)	Useful efficiency at nominal heat output ( $\eta_{th, nom}$ )	85.1	%
	Useful efficiency at minimum heat output (indicative) ( $\eta_{th, min}$ )	-	%
Auxiliary electricity consumption	At nominal heat output (e <sub>lmax</sub> )	-	kW
	At minimum heat output (e <sub>lmin</sub> )	-	kW
	In standby mode (e <sub>l sb</sub> )	-	kW
Type of heat output/room temperature control (select one)	Single stage heat output, no room temperature control	NO	
	Two or more manual stages, no room temperature control	NO	
	With mechanic thermostat room temperature control	NO	
	With electronic room temperature control	NO	
	With electronic room temperature control plus day timer	NO	
Other control options (multiple selections possible)	With electronic room temperature control plus week timer	NO	
	Room temperature control, with presence detection	NO	
	Room temperature control, with open window detection	NO	
Permanent pilot flame power requirement	With distance control option	NO	
	Pilot flame power requirement (if applicable) (P <sub>pilot</sub> )	N.A.	kW
<b>Observe the specific precautions for installation, assembly and maintenance indicated in the manual accompanying the product.</b>			
Issue date: 30.12.2021	Legal Representative	<b>CADEL s.r.l.</b> Via Foresto Sud, 7 - 31026 SANTA LUCIA DI PIAVE (TV) Tel. 0438 738869 - Fax 0438 73343 Partita IVA 03282100265 R.E.A. - TV 227665 - Reg. Soc. Trib. TV 185949	

# 13 TECHNICAL DOCUMENTATION FOR LOCAL SPACE HEATERS ACCORDING TO COMMISSION REGULATIONS (EU) 2015/1185 - (EU) 2015/1186 (PRODUCT FICHE)

Manufacturer	CADEL srl - Via Martiri delle Libertà 74 - 31025 Santa Lucia di Piave (TV) - Italy		
Trademark: model identifier	CADEL: SMART 60 V		
Description	Wood cooker stoves		
Indirect heating functionality	No		
Direct heat output	6,5 kW		
Indirect heat output	-		
CPR harmonised standard	EN 12815		
Notified body	IMQ Spa (N.B. 0051)		
Preferred fuel (unique)	Compressed wood with moisture content < 12 %	NO	
	Wood logs with moisture content ≤ 25 %	YES	
	Other woody biomass	NO	
$\eta_s$		75	%
EEL		113	-
Energy Efficiency Class (A++ to G scale)		A+	
Space heating emissions at nominal heat output	PM (al 13% O <sub>2</sub> )	21	mg/Nm <sup>3</sup>
	OGC (al 13% O <sub>2</sub> )	64	mg/Nm <sup>3</sup>
	CO (al 13% O <sub>2</sub> )	1062	mg/Nm <sup>3</sup>
	NO <sub>x</sub> (al 13% O <sub>2</sub> )	90	mg/Nm <sup>3</sup>
Space heating emissions at minimum heat output <i>Only required if correction factors F(2) or F(3) are applied</i>	PM (al 13% O <sub>2</sub> )	-	mg/Nm <sup>3</sup>
	OGC (al 13% O <sub>2</sub> )	-	mg/Nm <sup>3</sup>
	CO (al 13% O <sub>2</sub> )	-	mg/Nm <sup>3</sup>
	NO <sub>x</sub> (al 13% O <sub>2</sub> )	-	mg/Nm <sup>3</sup>
Heat output	Nominal heat output (P <sub>nom</sub> )	6.5	kW
	Minimum heat output (indicative) (P <sub>min</sub> )	-	kW
Useful efficiency (NCV as received)	Useful efficiency at nominal heat output ( $\eta_{th,nom}$ )	85.1	%
	Useful efficiency at minimum heat output (indicative) ( $\eta_{th,min}$ )	-	%
Auxiliary electricity consumption	At nominal heat output (e <sub>l,max</sub> )	0.050	kW
	At minimum heat output (e <sub>l,min</sub> )	-	kW
	In standby mode (e <sub>l,cb</sub> )	-	kW
Type of heat output/room temperature control (select one)	Single stage heat output, no room temperature control	NO	
	Two or more manual stages, no room temperature control	NO	
	With mechanic thermostat room temperature control	NO	
	With electronic room temperature control	NO	
	With electronic room temperature control plus day timer	NO	
Other control options (multiple selections possible)	With electronic room temperature control plus week timer	NO	
	Room temperature control, with presence detection	NO	
	Room temperature control, with open window detection	NO	
Permanent pilot flame power requirement	With distance control option	NO	
	Pilot flame power requirement (if applicable) (P <sub>pilot</sub> )	N.A.	kW
<b>Observe the specific precautions for installation, assembly and maintenance indicated in the manual accompanying the product.</b>			
Issue date: 30.12.2021	Legal Representative	<b>CADEL s.r.l.</b> Via Foresto Sud, 7 - 31026 SANTA LUCIA DI PIAVE (TV) Tel. 0438 738869 - Fax 0438 73343 Partita IVA 03282110265 R.E.A. TV 227665 - Reg. Soc. Trib. TV 185949	

# 14 TECHNICAL DOCUMENTATION FOR LOCAL SPACE HEATERS ACCORDING TO COMMISSION REGULATIONS (EU) 2015/1185 - (EU) 2015/1186 (PRODUCT FICHE)

Manufacturer	CADEL srl - Via Martiri delle Libertà 74 - 31025 Santa Lucia di Piave (TV) - Italy		
Trademark: model identifier	CADEL: SMART 60S		
Description	Wood stoves		
Indirect heating functionality	No		
Direct heat output	6,5 kW		
Indirect heat output	-		
CPR harmonised standard	EN 13240		
Notified body	IMQ Spa (N.B. 0051)		
Preferred fuel (unique)	Compressed wood with moisture content < 12 %	NO	
	Wood logs with moisture content ≤ 25 %	YES	
	Other woody biomass	NO	
$\eta_s$		75	%
EEL		113	-
Energy Efficiency Class (A++ to G scale)		A+	
Space heating emissions at nominal heat output	PM (al 13% O <sub>2</sub> )	21	mg/Nm <sup>3</sup>
	OGC (al 13% O <sub>2</sub> )	64	mg/Nm <sup>3</sup>
	CO (al 13% O <sub>2</sub> )	1062	mg/Nm <sup>3</sup>
	NO <sub>x</sub> (al 13% O <sub>2</sub> )	90	mg/Nm <sup>3</sup>
Space heating emissions at minimum heat output <i>Only required if correction factors F(2) or F(3) are applied</i>	PM (al 13% O <sub>2</sub> )	-	mg/Nm <sup>3</sup>
	OGC (al 13% O <sub>2</sub> )	-	mg/Nm <sup>3</sup>
	CO (al 13% O <sub>2</sub> )	-	mg/Nm <sup>3</sup>
	NO <sub>x</sub> (al 13% O <sub>2</sub> )	-	mg/Nm <sup>3</sup>
Heat output	Nominal heat output (P <sub>nom</sub> )	6.5	kW
	Minimum heat output (indicative) (P <sub>min</sub> )	-	kW
Useful efficiency (NCV as received)	Useful efficiency at nominal heat output ( $\eta_{th, nom}$ )	85.1	%
	Useful efficiency at minimum heat output (indicative) ( $\eta_{th, min}$ )	-	%
Auxiliary electricity consumption	At nominal heat output (el <sub>max</sub> )	-	kW
	At minimum heat output (el <sub>min</sub> )	-	kW
	In standby mode (el <sub>sb</sub> )	-	kW
Type of heat output/room temperature control (select one)	Single stage heat output, no room temperature control	NO	
	Two or more manual stages, no room temperature control	NO	
	With mechanic thermostat room temperature control	NO	
	With electronic room temperature control	NO	
	With electronic room temperature control plus day timer	NO	
Other control options (multiple selections possible)	With electronic room temperature control plus week timer	NO	
	Room temperature control, with presence detection	NO	
	Room temperature control, with open window detection	NO	
Permanent pilot flame power requirement	With distance control option	NO	
	Pilot flame power requirement (if applicable) (P <sub>pilot</sub> )	N.A.	kW
<b>Observe the specific precautions for installation, assembly and maintenance indicated in the manual accompanying the product.</b>			
Issue date: 30.12.2021	Legal Representative	<b>CADEL s.r.l.</b> Via Foresto Sud, 7 - 31026 SANTA LUCIA DI PIAVE (TV) Tel. 0438 738869 - Fax 0438 73343 Partita IVA 03282100265 R.E.A. - TV 227665 - Reg. Soc. Trib. TV 185949	

# 15 TECHNICAL DOCUMENTATION FOR LOCAL SPACE HEATERS ACCORDING TO COMMISSION REGULATIONS (EU) 2015/1185 - (EU) 2015/1186 (PRODUCT FICHE)

Manufacturer	CADEL srl - Via Martiri delle Libertà 74 - 31025 Santa Lucia di Piave (TV) - Italy		
Trademark: model identifier	CADEL: SMART 60 VS		
Description	Wood stoves		
Indirect heating functionality	No		
Direct heat output	6,5 kW		
Indirect heat output	-		
CPR harmonised standard	EN 13240		
Notified body	IMQ Spa (N.B. 0051)		
Preferred fuel (unique)	Compressed wood with moisture content < 12 %	NO	
	Wood logs with moisture content ≤ 25 %	YES	
	Other woody biomass	NO	
$\eta_s$		75	%
EEL		113	-
Energy Efficiency Class (A++ to G scale)		A+	
Space heating emissions at nominal heat output	PM (al 13% O <sub>2</sub> )	21	mg/Nm <sup>3</sup>
	OGC (al 13% O <sub>2</sub> )	64	mg/Nm <sup>3</sup>
	CO (al 13% O <sub>2</sub> )	1062	mg/Nm <sup>3</sup>
	NO <sub>x</sub> (al 13% O <sub>2</sub> )	90	mg/Nm <sup>3</sup>
Space heating emissions at minimum heat output <i>Only required if correction factors F(2) or F(3) are applied</i>	PM (al 13% O <sub>2</sub> )	-	mg/Nm <sup>3</sup>
	OGC (al 13% O <sub>2</sub> )	-	mg/Nm <sup>3</sup>
	CO (al 13% O <sub>2</sub> )	-	mg/Nm <sup>3</sup>
	NO <sub>x</sub> (al 13% O <sub>2</sub> )	-	mg/Nm <sup>3</sup>
Heat output	Nominal heat output (P <sub>nom</sub> )	6.5	kW
	Minimum heat output (indicative) (P <sub>min</sub> )	-	kW
Useful efficiency (NCV as received)	Useful efficiency at nominal heat output ( $\eta_{th, nom}$ )	85.1	%
	Useful efficiency at minimum heat output (indicative) ( $\eta_{th, min}$ )	-	%
Auxiliary electricity consumption	At nominal heat output (e <sub>lmax</sub> )	0.050	kW
	At minimum heat output (e <sub>lmin</sub> )	-	kW
	In standby mode (e <sub>l sb</sub> )	-	kW
Type of heat output/room temperature control (select one)	Single stage heat output, no room temperature control	NO	
	Two or more manual stages, no room temperature control	NO	
	With mechanic thermostat room temperature control	NO	
	With electronic room temperature control	NO	
	With electronic room temperature control plus day timer	NO	
Other control options (multiple selections possible)	With electronic room temperature control plus week timer	NO	
	Room temperature control, with presence detection	NO	
	Room temperature control, with open window detection	NO	
Permanent pilot flame power requirement	With distance control option	NO	
	Pilot flame power requirement (if applicable) (P <sub>pilot</sub> )	N.A.	kW
<b>Observe the specific precautions for installation, assembly and maintenance indicated in the manual accompanying the product.</b>			
Issue date: 30.12.2021	Legal Representative	<b>CADEL s.r.l.</b> Via Foresto Sud, 7 - 31026 SANTA LUCIA DI PIAVE (TV) Tel. 0438 738869 - Fax 0438 73343 Partita IVA 03282100265 R.E.A. TV 227665 - Reg. Soc. Trib. TV 185949	

# 16 TECHNICAL DOCUMENTATION FOR LOCAL SPACE HEATERS ACCORDING TO COMMISSION REGULATIONS (EU) 2015/1185 - (EU) 2015/1186 (PRODUCT FICHE)

Manufacturer	CADEL srl - Via Martiri delle Libertà 74 - 31025 Santa Lucia di Piave (TV) - Italy		
Trademark: model identifier	CADEL: SMART 80		
Description	Wood cooker stoves		
Indirect heating functionality	No		
Direct heat output	7,5 kW		
Indirect heat output	-		
CPR harmonised standard	EN 12815		
Notified body	IMQ Spa (N.B. 0051)		
Preferred fuel (unique)	Compressed wood with moisture content < 12 %	NO	
	Wood logs with moisture content ≤ 25 %	YES	
	Other woody biomass	NO	
$\eta_s$		76	%
EEL		110	-
Energy Efficiency Class (A++ to G scale)		A+	
Space heating emissions at nominal heat output	PM (al 13% O <sub>2</sub> )	20	mg/Nm <sup>3</sup>
	OGC (al 13% O <sub>2</sub> )	69	mg/Nm <sup>3</sup>
	CO (al 13% O <sub>2</sub> )	1167	mg/Nm <sup>3</sup>
	NO <sub>x</sub> (al 13% O <sub>2</sub> )	85	mg/Nm <sup>3</sup>
Space heating emissions at minimum heat output <i>Only required if correction factors F(2) or F(3) are applied</i>	PM (al 13% O <sub>2</sub> )	-	mg/Nm <sup>3</sup>
	OGC (al 13% O <sub>2</sub> )	-	mg/Nm <sup>3</sup>
	CO (al 13% O <sub>2</sub> )	-	mg/Nm <sup>3</sup>
	NO <sub>x</sub> (al 13% O <sub>2</sub> )	-	mg/Nm <sup>3</sup>
Heat output	Nominal heat output (P <sub>nom</sub> )	7.5	kW
	Minimum heat output (indicative) (P <sub>min</sub> )	-	kW
Useful efficiency (NCV as received)	Useful efficiency at nominal heat output ( $\eta_{th,nom}$ )	85.5	%
	Useful efficiency at minimum heat output (indicative) ( $\eta_{th,min}$ )	-	%
Auxiliary electricity consumption	At nominal heat output (el <sub>max</sub> )	-	kW
	At minimum heat output (el <sub>min</sub> )	-	kW
	In standby mode (el <sub>sb</sub> )	-	kW
Type of heat output/room temperature control (select one)	Single stage heat output, no room temperature control	NO	
	Two or more manual stages, no room temperature control	NO	
	With mechanic thermostat room temperature control	NO	
	With electronic room temperature control	NO	
	With electronic room temperature control plus day timer	NO	
Other control options (multiple selections possible)	With electronic room temperature control plus week timer	NO	
	Room temperature control, with presence detection	NO	
	Room temperature control, with open window detection	NO	
Permanent pilot flame power requirement	With distance control option	NO	
	Pilot flame power requirement (if applicable) (P <sub>pilot</sub> )	N.A.	kW
<b>Observe the specific precautions for installation, assembly and maintenance indicated in the manual accompanying the product.</b>			
Issue date: 30.12.2021	Legal Representative	<b>CADEL s.r.l.</b> Via Foresto Sud, 7 - 31026 SANTA LUCIA DI PIAVE (TV) Tel. 0438 738869 - Fax 0438 73343 Partita IVA 03282100265 R.E.A. - TV 227665 - Reg. Soc. Trib. TV 185949	



# 17 TECHNICAL DOCUMENTATION FOR LOCAL SPACE HEATERS ACCORDING TO COMMISSION REGULATIONS (EU) 2015/1185 - (EU) 2015/1186 (PRODUCT FICHE)

Manufacturer	CADEL srl - Via Martiri delle Libertà 74 - 31025 Santa Lucia di Piave (TV) - Italy		
Trademark: model identifier	CADEL: SMART 80V		
Description	Wood cooker stoves		
Indirect heating functionality	No		
Direct heat output	7,5 kW		
Indirect heat output	-		
CPR harmonised standard	EN 12815		
Notified body	IMQ Spa (N.B. 0051)		
Preferred fuel (unique)	Compressed wood with moisture content < 12 %	NO	
	Wood logs with moisture content ≤ 25 %	YES	
	Other woody biomass	NO	
$\eta_s$		75	%
EEL		110	-
Energy Efficiency Class (A++ to G scale)		A+	
Space heating emissions at nominal heat output	PM (al 13% O <sub>2</sub> )	20	mg/Nm <sup>3</sup>
	OGC (al 13% O <sub>2</sub> )	69	mg/Nm <sup>3</sup>
	CO (al 13% O <sub>2</sub> )	1167	mg/Nm <sup>3</sup>
	NO <sub>x</sub> (al 13% O <sub>2</sub> )	85	mg/Nm <sup>3</sup>
Space heating emissions at minimum heat output <i>Only required if correction factors F(2) or F(3) are applied</i>	PM (al 13% O <sub>2</sub> )	-	mg/Nm <sup>3</sup>
	OGC (al 13% O <sub>2</sub> )	-	mg/Nm <sup>3</sup>
	CO (al 13% O <sub>2</sub> )	-	mg/Nm <sup>3</sup>
	NO <sub>x</sub> (al 13% O <sub>2</sub> )	-	mg/Nm <sup>3</sup>
Heat output	Nominal heat output (P <sub>nom</sub> )	7.5	kW
	Minimum heat output (indicative) (P <sub>min</sub> )	-	kW
Useful efficiency (NCV as received)	Useful efficiency at nominal heat output ( $\eta_{th, nom}$ )	85.5	%
	Useful efficiency at minimum heat output (indicative) ( $\eta_{th, min}$ )	-	%
Auxiliary electricity consumption	At nominal heat output (e <sub>lmax</sub> )	0.050	kW
	At minimum heat output (e <sub>lmin</sub> )	-	kW
	In standby mode (e <sub>lcb</sub> )	-	kW
Type of heat output/room temperature control (select one)	Single stage heat output, no room temperature control	NO	
	Two or more manual stages, no room temperature control	NO	
	With mechanic thermostat room temperature control	NO	
	With electronic room temperature control	NO	
	With electronic room temperature control plus day timer	NO	
Other control options (multiple selections possible)	With electronic room temperature control plus week timer	NO	
	Room temperature control, with presence detection	NO	
	Room temperature control, with open window detection	NO	
Permanent pilot flame power requirement	With distance control option	NO	
	Pilot flame power requirement (if applicable) (P <sub>pilot</sub> )	N.A.	kW
<b>Observe the specific precautions for installation, assembly and maintenance indicated in the manual accompanying the product.</b>			
Issue date: 30.12.2021	Legal Representative	<b>CADEL s.r.l.</b> Via Foresto Sud, 7 - 31026 SANTA LUCIA DI PIAVE (TV) Tel. 0438 738869 - Fax 0438 73343 Partita IVA 03282110265 R.E.A. - TV 227665 - Reg. Soc. Trib. TV 185949	

# 18 TECHNICAL DOCUMENTATION FOR LOCAL SPACE HEATERS ACCORDING TO COMMISSION REGULATIONS (EU) 2015/1185 - (EU) 2015/1186 (PRODUCT FICHE)

Manufacturer	CADEL srl - Via Martiri delle Libertà 74 - 31025 Santa Lucia di Piave (TV) - Italy		
Trademark: model identifier	CADEL: SMART 80S - KOOK 80S		
Description	Wood stoves		
Indirect heating functionality	No		
Direct heat output	7,5 kW		
Indirect heat output	-		
CPR harmonised standard	EN 13240		
Notified body	IMQ Spa (N.B. 0051)		
Preferred fuel (unique)	Compressed wood with moisture content < 12 %	NO	
	Wood logs with moisture content ≤ 25 %	YES	
	Other woody biomass	NO	
$\eta_s$		76	%
EEL		110	-
Energy Efficiency Class (A++ to G scale)		A+	
Space heating emissions at nominal heat output	PM (al 13% O <sub>2</sub> )	20	mg/Nm <sup>3</sup>
	OGC (al 13% O <sub>2</sub> )	69	mg/Nm <sup>3</sup>
	CO (al 13% O <sub>2</sub> )	1167	mg/Nm <sup>3</sup>
	NO <sub>x</sub> (al 13% O <sub>2</sub> )	85	mg/Nm <sup>3</sup>
Space heating emissions at minimum heat output <i>Only required if correction factors F(2) or F(3) are applied</i>	PM (al 13% O <sub>2</sub> )	-	mg/Nm <sup>3</sup>
	OGC (al 13% O <sub>2</sub> )	-	mg/Nm <sup>3</sup>
	CO (al 13% O <sub>2</sub> )	-	mg/Nm <sup>3</sup>
	NO <sub>x</sub> (al 13% O <sub>2</sub> )	-	mg/Nm <sup>3</sup>
Heat output	Nominal heat output (P <sub>nom</sub> )	7.5	kW
	Minimum heat output (indicative) (P <sub>min</sub> )	-	kW
Useful efficiency (NCV as received)	Useful efficiency at nominal heat output ( $\eta_{th, nom}$ )	85.5	%
	Useful efficiency at minimum heat output (indicative) ( $\eta_{th, min}$ )	-	%
Auxiliary electricity consumption	At nominal heat output (el <sub>max</sub> )	-	kW
	At minimum heat output (el <sub>min</sub> )	-	kW
	In standby mode (el <sub>sb</sub> )	-	kW
Type of heat output/room temperature control (select one)	Single stage heat output, no room temperature control	NO	
	Two or more manual stages, no room temperature control	NO	
	With mechanic thermostat room temperature control	NO	
	With electronic room temperature control	NO	
	With electronic room temperature control plus day timer	NO	
Other control options (multiple selections possible)	With electronic room temperature control plus week timer	NO	
	Room temperature control, with presence detection	NO	
	Room temperature control, with open window detection	NO	
Permanent pilot flame power requirement	With distance control option	NO	
	Pilot flame power requirement (if applicable) (P <sub>pilot</sub> )	N.A.	kW
<b>Observe the specific precautions for installation, assembly and maintenance indicated in the manual accompanying the product.</b>			
Issue date: 30.12.2021	Legal Representative	<b>CADEL s.r.l.</b> Via Foresto Sud, 7 - 31026 SANTA LUCIA DI PIAVE (TV) Tel. 0438 738869 - Fax 0438 73343 Partita IVA 03282100265 R.E.A. TV 227665 - Reg. Soc. Trib. TV 185949	

# 19 TECHNICAL DOCUMENTATION FOR LOCAL SPACE HEATERS ACCORDING TO COMMISSION REGULATIONS (EU) 2015/1185 - (EU) 2015/1186 (PRODUCT FICHE)

Manufacturer	CADEL srl - Via Martiri delle Libertà 74 - 31025 Santa Lucia di Piave (TV) - Italy		
Trademark: model identifier	CADEL: SMART 80VS KOOK 80VS		
Description	Wood stoves		
Indirect heating functionality	No		
Direct heat output	7,5 kW		
Indirect heat output	-		
CPR harmonised standard	EN 13240		
Notified body	IMQ Spa (N.B. 0051)		
Preferred fuel (unique)	Compressed wood with moisture content < 12 %	NO	
	Wood logs with moisture content ≤ 25 %	YES	
	Other woody biomass	NO	
$\eta_s$		75	%
EEL		110	-
Energy Efficiency Class (A++ to G scale)		A+	
Space heating emissions at nominal heat output	PM (al 13% O <sub>2</sub> )	20	mg/Nm <sup>3</sup>
	OGC (al 13% O <sub>2</sub> )	69	mg/Nm <sup>3</sup>
	CO (al 13% O <sub>2</sub> )	1167	mg/Nm <sup>3</sup>
	NO <sub>x</sub> (al 13% O <sub>2</sub> )	85	mg/Nm <sup>3</sup>
Space heating emissions at minimum heat output <i>Only required if correction factors F(2) or F(3) are applied</i>	PM (al 13% O <sub>2</sub> )	-	mg/Nm <sup>3</sup>
	OGC (al 13% O <sub>2</sub> )	-	mg/Nm <sup>3</sup>
	CO (al 13% O <sub>2</sub> )	-	mg/Nm <sup>3</sup>
	NO <sub>x</sub> (al 13% O <sub>2</sub> )	-	mg/Nm <sup>3</sup>
Heat output	Nominal heat output (P <sub>nom</sub> )	7.5	kW
	Minimum heat output (indicative) (P <sub>min</sub> )	-	kW
Useful efficiency (NCV as received)	Useful efficiency at nominal heat output ( $\eta_{th, nom}$ )	85.5	%
	Useful efficiency at minimum heat output (indicative) ( $\eta_{th, min}$ )	-	%
Auxiliary electricity consumption	At nominal heat output (e <sub>lmax</sub> )	0,050	kW
	At minimum heat output (e <sub>lmin</sub> )	-	kW
	In standby mode (e <sub>l sb</sub> )	-	kW
Type of heat output/room temperature control (select one)	Single stage heat output, no room temperature control	NO	
	Two or more manual stages, no room temperature control	NO	
	With mechanic thermostat room temperature control	NO	
	With electronic room temperature control	NO	
	With electronic room temperature control plus day timer	NO	
Other control options (multiple selections possible)	With electronic room temperature control plus week timer	NO	
	Room temperature control, with presence detection	NO	
	Room temperature control, with open window detection	NO	
Permanent pilot flame power requirement	With distance control option	NO	
	Pilot flame power requirement (if applicable) (P <sub>pilot</sub> )	N.A.	kW
<b>Observe the specific precautions for installation, assembly and maintenance indicated in the manual accompanying the product.</b>			
Issue date: 30.12.2021	Legal Representative	<b>CADEL s.r.l.</b> Via Foresto Sud, 7 - 31026 SANTA LUCIA DI PIAVE (TV) Tel. 0438 738869 - Fax 0438 73343 Partita IVA 03282100265 R.E.A. TV 227665 - Reg. Soc. Trib. TV 185949	

## 20 TECHNICAL DOCUMENTATION FOR LOCAL SPACE HEATERS ACCORDING TO COMMISSION REGULATIONS (EU) 2015/1185 - (EU) 2015/1186 (PRODUCT FICHE)

Manufacturer	CADEL srl - Via Martiri delle Libertà 74 - 31025 Santa Lucia di Piave (TV) - Italy		
Trademark: model identifier	CADEL: KOOK 60		
Description	Wood cooker stoves		
Indirect heating functionality	No		
Direct heat output	6,2 kW		
Indirect heat output	-		
CPR harmonised standard	EN 12815		
Notified body	IMQ Spa (N.B. 0051)		
Preferred fuel (unique)	Compressed wood with moisture content < 12 %	NO	
	Wood logs with moisture content ≤ 25 %	YES	
	Other woody biomass	NO	
$\eta_s$		74	%
EEL		112	-
Energy Efficiency Class (A++ to G scale)		A+	
Space heating emissions at nominal heat output	PM (al 13% O <sub>2</sub> )	29.8	mg/Nm <sup>3</sup>
	OGC (al 13% O <sub>2</sub> )	69	mg/Nm <sup>3</sup>
	CO (al 13% O <sub>2</sub> )	1209	mg/Nm <sup>3</sup>
	NO <sub>x</sub> (al 13% O <sub>2</sub> )	78	mg/Nm <sup>3</sup>
Space heating emissions at minimum heat output <i>Only required if correction factors F(2) or F(3) are applied</i>	PM (al 13% O <sub>2</sub> )	-	mg/Nm <sup>3</sup>
	OGC (al 13% O <sub>2</sub> )	-	mg/Nm <sup>3</sup>
	CO (al 13% O <sub>2</sub> )	-	mg/Nm <sup>3</sup>
	NO <sub>x</sub> (al 13% O <sub>2</sub> )	-	mg/Nm <sup>3</sup>
Heat output	Nominal heat output (P <sub>nom</sub> )	6.2	kW
	Minimum heat output (indicative) (P <sub>min</sub> )	-	kW
Useful efficiency (NCV as received)	Useful efficiency at nominal heat output ( $\eta_{th,nom}$ )	84.1	%
	Useful efficiency at minimum heat output (indicative) ( $\eta_{th,min}$ )	-	%
Auxiliary electricity consumption	At nominal heat output (el <sub>max</sub> )	-	kW
	At minimum heat output (el <sub>min</sub> )	-	kW
	In standby mode (el <sub>sb</sub> )	-	kW
Type of heat output/room temperature control (select one)	Single stage heat output, no room temperature control	NO	
	Two or more manual stages, no room temperature control	NO	
	With mechanic thermostat room temperature control	NO	
	With electronic room temperature control	NO	
	With electronic room temperature control plus day timer	NO	
Other control options (multiple selections possible)	With electronic room temperature control plus week timer	NO	
	Room temperature control, with presence detection	NO	
	Room temperature control, with open window detection	NO	
Permanent pilot flame power requirement	With distance control option	NO	
	Pilot flame power requirement (if applicable) (P <sub>pilot</sub> )	N.A.	kW
<b>Observe the specific precautions for installation, assembly and maintenance indicated in the manual accompanying the product.</b>			
Issue date: 30.12.2021	Legal Representative	<b>CADEL s.r.l.</b> Via Foresto Sud, 7 - 31026 SANTA LUCIA DI PIAVE (TV) Tel. 0438 738869 - Fax 0438 73343 Partita IVA 03282100265 R.E.A. TV 227665 - Reg. Soc. Trib. TV 185949	

## 21 TECHNICAL DOCUMENTATION FOR LOCAL SPACE HEATERS ACCORDING TO COMMISSION REGULATIONS (EU) 2015/1185 - (EU) 2015/1186 (PRODUCT FICHE)

Manufacturer	CADEL srl - Via Martiri delle Libertà 74 - 31025 Santa Lucia di Piave (TV) - Italy		
Trademark: model identifier	CADEL: KOOK 60V		
Description	Wood cooker stoves		
Indirect heating functionality	No		
Direct heat output	6,2 kW		
Indirect heat output	-		
CPR harmonised standard	EN 12815		
Notified body	IMQ Spa (N.B. 0051)		
Preferred fuel (unique)	Compressed wood with moisture content < 12 %	NO	
	Wood logs with moisture content ≤ 25 %	YES	
	Other woody biomass	NO	
$\eta_s$		74	%
EEL		112	-
Energy Efficiency Class (A++ to G scale)		A+	
Space heating emissions at nominal heat output	PM (al 13% O <sub>2</sub> )	29.8	mg/Nm <sup>3</sup>
	OGC (al 13% O <sub>2</sub> )	69	mg/Nm <sup>3</sup>
	CO (al 13% O <sub>2</sub> )	1209	mg/Nm <sup>3</sup>
	NO <sub>x</sub> (al 13% O <sub>2</sub> )	78	mg/Nm <sup>3</sup>
Space heating emissions at minimum heat output <i>Only required if correction factors F(2) or F(3) are applied</i>	PM (al 13% O <sub>2</sub> )	-	mg/Nm <sup>3</sup>
	OGC (al 13% O <sub>2</sub> )	-	mg/Nm <sup>3</sup>
	CO (al 13% O <sub>2</sub> )	-	mg/Nm <sup>3</sup>
	NO <sub>x</sub> (al 13% O <sub>2</sub> )	-	mg/Nm <sup>3</sup>
Heat output	Nominal heat output (P <sub>nom</sub> )	6.2	kW
	Minimum heat output (indicative) (P <sub>min</sub> )	-	kW
Useful efficiency (NCV as received)	Useful efficiency at nominal heat output ( $\eta_{th,nom}$ )	84.1	%
	Useful efficiency at minimum heat output (indicative) ( $\eta_{th,min}$ )	-	%
Auxiliary electricity consumption	At nominal heat output (e <sub>l,max</sub> )	0,050	kW
	At minimum heat output (e <sub>l,min</sub> )	-	kW
	In standby mode (e <sub>l,cb</sub> )	-	kW
Type of heat output/room temperature control (select one)	Single stage heat output, no room temperature control	NO	
	Two or more manual stages, no room temperature control	NO	
	With mechanic thermostat room temperature control	NO	
	With electronic room temperature control	NO	
	With electronic room temperature control plus day timer	NO	
Other control options (multiple selections possible)	With electronic room temperature control plus week timer	NO	
	Room temperature control, with presence detection	NO	
	Room temperature control, with open window detection	NO	
Permanent pilot flame power requirement	With distance control option	NO	
	Pilot flame power requirement (if applicable) (P <sub>pilot</sub> )	N.A.	kW
<b>Observe the specific precautions for installation, assembly and maintenance indicated in the manual accompanying the product.</b>			
Issue date: 30.12.2021	Legal Representative	<b>CADEL s.r.l.</b> Via Foresto Sud, 7 - 31026 SANTA LUCIA DI PIAVE (TV) Tel. 0438 738869 - Fax 0438 73343 Partita IVA 03282110265 R.E.A. TV 227665 - Reg. Soc. Trib. TV 185949	

## 22 TECHNICAL DOCUMENTATION FOR LOCAL SPACE HEATERS ACCORDING TO COMMISSION REGULATIONS (EU) 2015/1185 - (EU) 2015/1186 (PRODUCT FICHE)

Manufacturer	CADEL srl - Via Martiri delle Libertà 74 - 31025 Santa Lucia di Piave (TV) - Italy		
Trademark: model identifier	CADEL: KOOK 80		
Description	Wood cooker stoves		
Indirect heating functionality	No		
Direct heat output	7.5 kW		
Indirect heat output	-		
CPR harmonised standard	EN 12815		
Notified body	IMQ Primacontrol SRL (N.B. 1881)		
Preferred fuel (unique)	Compressed wood with moisture content < 12 %	NO	
	Wood logs with moisture content ≤ 25 %	YES	
	Other woody biomass	NO	
$\eta_s$		73	%
EEL		110	-
Energy Efficiency Class (A++ to G scale)		A+	
Space heating emissions at nominal heat output	PM (al 13% O <sub>2</sub> )	27	mg/Nm <sup>3</sup>
	OGC (al 13% O <sub>2</sub> )	29	mg/Nm <sup>3</sup>
	CO (al 13% O <sub>2</sub> )	916	mg/Nm <sup>3</sup>
	NO <sub>x</sub> (al 13% O <sub>2</sub> )	95	mg/Nm <sup>3</sup>
Space heating emissions at minimum heat output <i>Only required if correction factors F(2) or F(3) are applied</i>	PM (al 13% O <sub>2</sub> )	-	mg/Nm <sup>3</sup>
	OGC (al 13% O <sub>2</sub> )	-	mg/Nm <sup>3</sup>
	CO (al 13% O <sub>2</sub> )	-	mg/Nm <sup>3</sup>
	NO <sub>x</sub> (al 13% O <sub>2</sub> )	-	mg/Nm <sup>3</sup>
Heat output	Nominal heat output (P <sub>nom</sub> )	7.5	kW
	Minimum heat output (indicative) (P <sub>min</sub> )	-	kW
Useful efficiency (NCV as received)	Useful efficiency at nominal heat output ( $\eta_{th, nom}$ )	82.5	%
	Useful efficiency at minimum heat output (indicative) ( $\eta_{th, min}$ )	-	%
Auxiliary electricity consumption	At nominal heat output (e <sub>lmax</sub> )	0,050	kW
	At minimum heat output (e <sub>lmin</sub> )	-	kW
	In standby mode (e <sub>l sb</sub> )	-	kW
Type of heat output/room temperature control (select one)	Single stage heat output, no room temperature control	NO	
	Two or more manual stages, no room temperature control	NO	
	With mechanic thermostat room temperature control	NO	
	With electronic room temperature control	NO	
	With electronic room temperature control plus day timer	NO	
Other control options (multiple selections possible)	With electronic room temperature control plus week timer	NO	
	Room temperature control, with presence detection	NO	
	Room temperature control, with open window detection	NO	
Permanent pilot flame power requirement	With distance control option	NO	
	Pilot flame power requirement (if applicable) (P <sub>pilot</sub> )	N.A.	kW
<b>Observe the specific precautions for installation, assembly and maintenance indicated in the manual accompanying the product.</b>			
Issue date: 30.12.2021	Legal Representative	<b>CADEL s.r.l.</b> Via Foresto Sud, 7 - 31026 SANTA LUCIA DI PIAVE (TV) Tel. 0438 738869 - Fax 0438 73343 Partita IVA 03282100265 R.E.A. - TV 227665 - Reg. Soc. Trib. TV 185949	

## 23 TECHNICAL DOCUMENTATION FOR LOCAL SPACE HEATERS ACCORDING TO COMMISSION REGULATIONS (EU) 2015/1185 - (EU) 2015/1186 (PRODUCT FICHE)

Manufacturer	CADEL srl - Via Martiri delle Libertà 74 - 31025 Santa Lucia di Piave (TV) - Italy		
Trademark: model identifier	CADEL: KOOK 80V		
Description	Wood cooker stoves		
Indirect heating functionality	No		
Direct heat output	7.5 kW		
Indirect heat output	-		
CPR harmonised standard	EN 12815		
Notified body	IMQ Primacontrol SRL (N.B. 1881)		
Preferred fuel (unique)	Compressed wood with moisture content < 12 %	NO	
	Wood logs with moisture content ≤ 25 %	YES	
	Other woody biomass	NO	
$\eta_s$		74	%
EEL		111	-
Energy Efficiency Class (A++ to G scale)		A+	
Space heating emissions at nominal heat output	PM (al 13% O <sub>2</sub> )	26	mg/Nm <sup>3</sup>
	OGC (al 13% O <sub>2</sub> )	45	mg/Nm <sup>3</sup>
	CO (al 13% O <sub>2</sub> )	856	mg/Nm <sup>3</sup>
	NO <sub>x</sub> (al 13% O <sub>2</sub> )	60	mg/Nm <sup>3</sup>
Space heating emissions at minimum heat output <i>Only required if correction factors F(2) or F(3) are applied</i>	PM (al 13% O <sub>2</sub> )	-	mg/Nm <sup>3</sup>
	OGC (al 13% O <sub>2</sub> )	-	mg/Nm <sup>3</sup>
	CO (al 13% O <sub>2</sub> )	-	mg/Nm <sup>3</sup>
	NO <sub>x</sub> (al 13% O <sub>2</sub> )	-	mg/Nm <sup>3</sup>
Heat output	Nominal heat output (P <sub>nom</sub> )	7.5	kW
	Minimum heat output (indicative) (P <sub>min</sub> )	-	kW
Useful efficiency (NCV as received)	Useful efficiency at nominal heat output ( $\eta_{th,nom}$ )	84	%
	Useful efficiency at minimum heat output (indicative) ( $\eta_{th,min}$ )	-	%
Auxiliary electricity consumption	At nominal heat output (e <sub>l,max</sub> )	0,050	kW
	At minimum heat output (e <sub>l,min</sub> )	-	kW
	In standby mode (e <sub>l,cb</sub> )	-	kW
Type of heat output/room temperature control (select one)	Single stage heat output, no room temperature control	NO	
	Two or more manual stages, no room temperature control	NO	
	With mechanic thermostat room temperature control	NO	
	With electronic room temperature control	NO	
	With electronic room temperature control plus day timer	NO	
Other control options (multiple selections possible)	With electronic room temperature control plus week timer	NO	
	Room temperature control, with presence detection	NO	
	Room temperature control, with open window detection	NO	
Permanent pilot flame power requirement	With distance control option	NO	
	Pilot flame power requirement (if applicable) (P <sub>pilot</sub> )	N.A.	kW
<b>Observe the specific precautions for installation, assembly and maintenance indicated in the manual accompanying the product.</b>			
Issue date: 30.12.2021	Legal Representative	<b>CADEL s.r.l.</b> Via Foresto Sud, 7 - 31026 SANTA LUCIA DI PIAVE (TV) Tel. 0438 738869 - Fax 0438 73343 Partita IVA 03282110265 R.E.A. TV 227665 - Reg. Soc. Trib. TV 185949	

## 24 TECHNICAL DOCUMENTATION FOR LOCAL SPACE HEATERS ACCORDING TO COMMISSION REGULATIONS (EU) 2015/1185 - (EU) 2015/1186 (PRODUCT FICHE)

Manufacturer	CADEL srl - Via Martiri delle Libertà 74 - 31025 Santa Lucia di Piave (TV) - Italy		
Trademark: model identifier	CADEL: KOOK 90		
Description	Wood cooker stoves		
Indirect heating functionality	No		
Direct heat output	7.5 kW		
Indirect heat output	-		
CPR harmonised standard	EN 12815		
Notified body	IMQ Spa (N.B. 0051)		
Preferred fuel (unique)	Compressed wood with moisture content < 12 %	NO	
	Wood logs with moisture content ≤ 25 %	YES	
	Other woody biomass	NO	
$\eta_s$		73	%
EEL		110	-
Energy Efficiency Class (A++ to G scale)		A+	
Space heating emissions at nominal heat output	PM (al 13% O <sub>2</sub> )	27	mg/Nm <sup>3</sup>
	OGC (al 13% O <sub>2</sub> )	29	mg/Nm <sup>3</sup>
	CO (al 13% O <sub>2</sub> )	916	mg/Nm <sup>3</sup>
	NO <sub>x</sub> (al 13% O <sub>2</sub> )	95	mg/Nm <sup>3</sup>
Space heating emissions at minimum heat output <i>Only required if correction factors F(2) or F(3) are applied</i>	PM (al 13% O <sub>2</sub> )	-	mg/Nm <sup>3</sup>
	OGC (al 13% O <sub>2</sub> )	-	mg/Nm <sup>3</sup>
	CO (al 13% O <sub>2</sub> )	-	mg/Nm <sup>3</sup>
	NO <sub>x</sub> (al 13% O <sub>2</sub> )	-	mg/Nm <sup>3</sup>
Heat output	Nominal heat output (P <sub>nom</sub> )	7.5	kW
	Minimum heat output (indicative) (P <sub>min</sub> )	-	kW
Useful efficiency (NCV as received)	Useful efficiency at nominal heat output ( $\eta_{th,nom}$ )	82.5	%
	Useful efficiency at minimum heat output (indicative) ( $\eta_{th,min}$ )	-	%
Auxiliary electricity consumption	At nominal heat output (el <sub>max</sub> )	-	kW
	At minimum heat output (el <sub>min</sub> )	-	kW
	In standby mode (el <sub>sb</sub> )	-	kW
Type of heat output/room temperature control (select one)	Single stage heat output, no room temperature control	NO	
	Two or more manual stages, no room temperature control	NO	
	With mechanic thermostat room temperature control	NO	
	With electronic room temperature control	NO	
	With electronic room temperature control plus day timer	NO	
Other control options (multiple selections possible)	With electronic room temperature control plus week timer	NO	
	Room temperature control, with presence detection	NO	
	Room temperature control, with open window detection	NO	
Permanent pilot flame power requirement	With distance control option	NO	
	Pilot flame power requirement (if applicable) (P <sub>pilot</sub> )	N.A.	kW
<b>Observe the specific precautions for installation, assembly and maintenance indicated in the manual accompanying the product.</b>			
Issue date: 30.12.2021	Legal Representative	<b>CADEL s.r.l.</b> Via Foresto Sud, 7 - 31026 SANTA LUCIA DI PIAVE (TV) Tel. 0438 738869 - Fax 0438 73343 Partita IVA 03282100265 R.E.A. TV 227665 - Reg. Soc. Trib. TV 185949	



## 25 TECHNICAL DOCUMENTATION FOR LOCAL SPACE HEATERS ACCORDING TO COMMISSION REGULATIONS (EU) 2015/1185 - (EU) 2015/1186 (PRODUCT FICHE)

Manufacturer	CADEL srl - Via Martiri della Libertà 74 - 31025 Santa Lucia di Piave (TV) - Italy		
Trademark: model identifier	CADEL: KOOK 90V		
Description	Wood cooker stoves		
Indirect heating functionality	No		
Direct heat output	7.5 kW		
Indirect heat output	-		
CPR harmonised standard	EN 12815		
Notified body	IMQ Spa (N.B. 0051)		
Preferred fuel (unique)	Compressed wood with moisture content < 12 %	NO	
	Wood logs with moisture content ≤ 25 %	YES	
	Other woody biomass	NO	
$\eta_s$		74	%
EEL		111	-
Energy Efficiency Class (A++ to G scale)		A+	
Space heating emissions at nominal heat output	PM (al 13% O <sub>2</sub> )	26	mg/Nm <sup>3</sup>
	OGC (al 13% O <sub>2</sub> )	45	mg/Nm <sup>3</sup>
	CO (al 13% O <sub>2</sub> )	856	mg/Nm <sup>3</sup>
	NO <sub>x</sub> (al 13% O <sub>2</sub> )	60	mg/Nm <sup>3</sup>
Space heating emissions at minimum heat output <i>Only required if correction factors F(2) or F(3) are applied</i>	PM (al 13% O <sub>2</sub> )	-	mg/Nm <sup>3</sup>
	OGC (al 13% O <sub>2</sub> )	-	mg/Nm <sup>3</sup>
	CO (al 13% O <sub>2</sub> )	-	mg/Nm <sup>3</sup>
	NO <sub>x</sub> (al 13% O <sub>2</sub> )	-	mg/Nm <sup>3</sup>
Heat output	Nominal heat output (P <sub>nom</sub> )	7.5	kW
	Minimum heat output (indicative) (P <sub>min</sub> )	-	kW
Useful efficiency (NCV as received)	Useful efficiency at nominal heat output ( $\eta_{th,nom}$ )	84	%
	Useful efficiency at minimum heat output (indicative) ( $\eta_{th,min}$ )	-	%
Auxiliary electricity consumption	At nominal heat output (eI <sub>max</sub> )	0.050	kW
	At minimum heat output (eI <sub>min</sub> )	-	kW
	In standby mode (eI <sub>sb</sub> )	-	kW
Type of heat output/room temperature control (select one)	Single stage heat output, no room temperature control	NO	
	Two or more manual stages, no room temperature control	NO	
	With mechanic thermostat room temperature control	NO	
	With electronic room temperature control	NO	
	With electronic room temperature control plus day timer	NO	
Other control options (multiple selections possible)	With electronic room temperature control plus week timer	NO	
	Room temperature control, with presence detection	NO	
	Room temperature control, with open window detection	NO	
Permanent pilot flame power requirement	With distance control option	NO	
	Pilot flame power requirement (if applicable) (P <sub>pilot</sub> )	N.A.	kW
<b>Observe the specific precautions for installation, assembly and maintenance indicated in the manual accompanying the product.</b>			
Issue date: 30.12.2021	Legal Representative	<b>CADEL s.r.l.</b> Via Foresto Sud, 7 - 31026 SANTA LUCIA DI PIAVE (TV) Tel. 0438 738869 - Fax 0438 73343 Partita IVA 03282110265 R.E.A. - TV 227665 - Reg. Soc. Trib. TV 185949	

## 26 TECHNICAL DOCUMENTATION FOR LOCAL SPACE HEATERS ACCORDING TO COMMISSION REGULATIONS (EU) 2015/1185 - (EU) 2015/1186 (PRODUCT FICHE)

Manufacturer	CADEL srl - Via Martiri delle Libertà 74 - 31025 Santa Lucia di Piave (TV) - Italy		
Trademark: model identifier	FREEPOINT: FRIDA 80		
Description	Wood cooker stoves		
Indirect heating functionality	No		
Direct heat output	7,5 kW		
Indirect heat output	-		
CPR harmonised standard	EN 12815		
Notified body	IMQ Spa (N.B. 0051)		
Preferred fuel (unique)	Compressed wood with moisture content < 12 %	NO	
	Wood logs with moisture content ≤ 25 %	YES	
	Other woody biomass	NO	
$\eta_s$		76	%
EEL		110	-
Energy Efficiency Class (A++ to G scale)		A+	
Space heating emissions at nominal heat output	PM (al 13% O <sub>2</sub> )	20	mg/Nm <sup>3</sup>
	OGC (al 13% O <sub>2</sub> )	69	mg/Nm <sup>3</sup>
	CO (al 13% O <sub>2</sub> )	1167	mg/Nm <sup>3</sup>
	NO <sub>x</sub> (al 13% O <sub>2</sub> )	85	mg/Nm <sup>3</sup>
Space heating emissions at minimum heat output <i>Only required if correction factors F(2) or F(3) are applied</i>	PM (al 13% O <sub>2</sub> )	-	mg/Nm <sup>3</sup>
	OGC (al 13% O <sub>2</sub> )	-	mg/Nm <sup>3</sup>
	CO (al 13% O <sub>2</sub> )	-	mg/Nm <sup>3</sup>
	NO <sub>x</sub> (al 13% O <sub>2</sub> )	-	mg/Nm <sup>3</sup>
Heat output	Nominal heat output (P <sub>nom</sub> )	7.5	kW
	Minimum heat output (indicative) (P <sub>min</sub> )	-	kW
Useful efficiency (NCV as received)	Useful efficiency at nominal heat output ( $\eta_{th, nom}$ )	85.5	%
	Useful efficiency at minimum heat output (indicative) ( $\eta_{th, min}$ )	-	%
Auxiliary electricity consumption	At nominal heat output (e <sub>lmax</sub> )	-	kW
	At minimum heat output (e <sub>lmin</sub> )	-	kW
	In standby mode (e <sub>lcb</sub> )	-	kW
Type of heat output/room temperature control (select one)	Single stage heat output, no room temperature control	NO	
	Two or more manual stages, no room temperature control	NO	
	With mechanic thermostat room temperature control	NO	
	With electronic room temperature control	NO	
	With electronic room temperature control plus day timer	NO	
Other control options (multiple selections possible)	With electronic room temperature control plus week timer	NO	
	Room temperature control, with presence detection	NO	
	Room temperature control, with open window detection	NO	
Permanent pilot flame power requirement	With distance control option	NO	
	Pilot flame power requirement (if applicable) (P <sub>pilot</sub> )	N.A.	kW
<b>Observe the specific precautions for installation, assembly and maintenance indicated in the manual accompanying the product.</b>			
Issue date: 31.08.2023	Legal Representative	<b>CADEL s.r.l.</b> Via Foresto Sud, 7 - 31026 SANTA LUCIA DI PIAVE (TV) Tel. 0438 738869 - Fax 0438 73343 Partita IVA 03282100265 R.E.A. TV 227665 - Reg. Soc. Trib. TV 185949	





89023007A

Rev. 00-2023

**CADEL srl**  
**31025 S. Lucia di Piave - TV**  
**Via Martiri della Libertà, 74 - Italy**  
**Tel. +39 0438 1520200**

**[www.cadelsrl.com](http://www.cadelsrl.com)**  
**[www.free-point.it](http://www.free-point.it)**  
**[www.pegasoheating.com](http://www.pegasoheating.com)**