

USER MANUAL

Pellet Stove







Original Instructions | ©2022 CADEL srl | All rights reserved - Tutti i diritti riservati

**VERA 7, 7.0, 7.0 UP - INDIGO EVO, INDIGO EVO 7 - LORD7, 7.0 -
FLOYD 5.0 - FLOYD 7.0 - ELANE 9 - AMARANTO 9**

SUMMARY

1	MANUAL SIMBOLOGY	3
2	DEAR CUSTOMER	3
2.1	REVISIONS TO THE PUBLICATION	4
2.2	CARE OF THE MANUAL AND HOW TO CONSULT IT ...	4
3	SAFETY REQUIREMENTS	5
4	CAUTIONS - WARRANTY CONDITIONS	6
4.1	INFORMATION	6
4.2	INTENDED USE	6
4.3	PRODUCT PERFORMANCE CHECKS.....	6
4.4	WARRANTY CONDITIONS	7
5	SPARE PARTS	8
6	DISPOSAL OF MATERIALS	8
6.1	WARNINGS FOR THE CORRECT DISPOSAL OF THE PRODUCT	8
6.2	INFORMATION FOR MANAGEMENT OF ELECTRIC AND ELECTRONIC APPLIANCE WASTE CONTAINING BATTERIES OR ACCUMULATORS	9
6.3	INSTRUCTIONS FOR PACKAGING DISPOSAL	9
7	WIFI - BLUETOOTH CONNECTION	10
7.1	NAVEL STAND ALONE (OPTIONAL)	10
8	USE	11
8.1	INTRODUCTION	11
8.2	CONTROL PANEL	12
8.3	USER MENU	13
8.3.1	MENU M1 - CLOCK SETTING	16
8.3.2	MENU M2 - CHRONO SETTING	16
8.3.3	MENU M3 - LANGUAGE SELECTION	18
8.3.4	MENU M4 - STAND-BY	18
8.3.5	MENU M5 - BUZZER.....	19
8.3.6	MENU M6 - FIRST LOAD	19
8.3.7	MENU M7 - STOVE STATUS.....	19
8.3.8	MENU M8 - ENGINEER SETTINGS.....	19
8.3.9	MENU M9 - PELLET TYPE	20
8.3.10	MENU MA - FLUE TYPE.....	20
8.3.11	MENU MB - EXIT	20
8.4	STOVE SWITCH-ON.....	20
8.5	FAILED IGNITION	21
8.6	POWER FAILURE.....	21
8.7	TEMPERATURE SETTING.....	21
8.8	POWER SETTING	21
8.9	SWITCHING OFF	21
8.10	CONNECTION TO THE EXTERNAL THERMOSTAT	21
9	FUEL	21
9.1	FUEL	21
9.2	PELLET SUPPLY	22
9.3	PELLET REFUELLING TIMER.....	22
10	VENTILATION	23
11	REMOTE CONTROL (OPTIONAL)	23
12	SAFETY DEVICES AND ALARMS	24
12.1	PRESSURE SWITCH.....	24
12.2	SMOKE TEMPERATURE PROBE	24
12.3	CONTACT THERMOSTAT IN THE FUEL HOPPER.....	24
12.4	ELECTRICAL SAFETY	24
12.5	SMOKE FAN	24
12.6	GEAR MOTOR.....	24
12.7	TEMPORARY POWER CUT.....	24
12.8	FAILED START-UP	24
12.9	BLACKOUT WITH THE BOILER ON	25
12.10	FLUE GAS TEMPERATURE PROBE ALARM.....	25
12.11	FLUE GAS OVERTEMPERATURE ALARM.....	25
12.12	FAULTY FLUE GAS ENCODER ALARM	25
12.13	FAILED IGNITION ALARM	26
12.14	NO PELLET ALARM	26
12.15	THERMAL SAFETY OVERHEATING ALARM	26
12.16	NO NEGATIVE PRESSURE ALARM	26
12.17	ALARM ALERTS	27
12.18	ALARM RESET	29
13	ROUTINE MAINTENANCE	29
13.1	INTRODUCTION	29
13.2	BEFORE EACH START-UP	30
13.3	BURNING POT AND ASH TRAY CLEANING	30
13.4	HOPPER CLEANING	31
13.5	FUME PIPES ANNUAL CLEANING	31
13.6	GENERAL CLEANING.....	31
13.7	CLEANING OF PAINTED METAL PANELS	31
13.8	CLEANING OF CERAMIC AND STONE PANELS	31
13.9	GASKET REPLACEMENT.....	32
13.10	GLASS CLEANING	32
13.11	SHUTDOWN (END OF SEASON)	32
13.12	CHECKING THE INNER COMPONENTS.....	32
14	IN CASE OF ANOMALY	33
14.1	PROBLEM SOLVING	33
15	TECHNICAL DOCUMENTATION FOR LOCAL SPACE HEATERS ACCORDING TO COMMISSION REGULATIONS (EU) 2015/1185 - (EU) 2015/1186 (PRODUCT FICHE)	36

1 MANUAL SIMBOLOGY

	USER
	AUTHORISED TECHNICIAN (ONLY to interpret or the Stove-manufacturer or the Authorized Technician of Technical Assistance Service approved by the Stove-manufacturer)
	SPECIALIZED STOVE-REPAIRER
	CAUTION: READ CAREFULLY THE NOTE
	CAUTION: DANGER OR IRREVERSIBLE DAMAGE POSSIBILITY

- The icons with the stylized figures indicates whom the subject dealt in the paragraph is addressed to (between the User and/or the Authorized Technician and/or the Specialized Stove-repairer).
- WARNING symbols indicates an important note.

2 DEAR CUSTOMER

Dear Customer,

Our products are designed and manufactured in accordance with standards in force, with high quality materials and using our extensive experience in the transformation processes.

To get the best performance, we suggest you read the instructions in this manual carefully.

This installation guide is an integral part of the product: ensure that the manual is always supplied with the appliance, even if it changes owner. If the manual is lost, you can request another copy from the local Technical Dept. or download it directly from the company's website.

All local regulations, including those referring to national and European standards, must be observed when installing the appliance. In Italy, for the installation of systems with a biomass below 35KW, refer to the Ministerial Decree 37/08 and the qualified installation technician with the suitable requirements must issue a certificate of compliance for the system installed. (By system we intend Stove+Flue+Air inlet).

Our solid bio-combustible products, (hereinafter called "Products") are designed and manufactured in compliance with one of the following European standard harmonised to Regulation (UE) no. 305/2011 for construction products:

EN 14785: "Residential space heating appliances fired by wood pellets"

EN 13240: "Room heaters fired by solid fuel."

EN 13229: "Inset appliances including open fires fired by solid fuels"

EN 12815: "Residential cookers fired by solid fuel"

The products also comply with the essential requirements of Directive **2009/125/EC (Eco Design)** and, where applicable, Directives:

2014/35/EU (LVD - Low Voltage directive)

2014/30/EU (EMC - Electromagnetic Compatibility directive)

2014/53/EU (RED - Radio Equipment directive)

2011/65/EU (ROhS)

Hereby CADEL S.r.l. declares that the radio equipment type **Easy Connect Plus + Navel Stand Alone** is in compliance with Directive 2014/53/EU.

According to (EU) No. 305/2011 regulation, the "Declaration of Performance" and "Declaration of Conformity" are available online,

in the download area, at the web sites:

- www.cadelsrl.com
- www.free-point.it
- www.pegasoheating.com

Having specified the above, we highlight and report that:

- **This manual and technical data sheet, also available on our website**, bear all of the specific indications and necessary and essential information to choose the product, to install it correctly and to properly size the smoke expulsion system;
- the Products must be **installed, controlled and serviced** by a qualified operator, according to the instructions in this manual and in compliance with the laws and installation and maintenance standards in force in individual countries, so as to provide an efficient heating system, properly sized according to the needs of the home.
- **If the Products are thermally stressed**, constantly operating for several hours at high power (e.g. 3, 4 hours a day at outputs P4 or P5), we recommend more frequent cleaning and reducing the interval between routine maintenance operations according to the operating condition of the product. We furthermore point out that these operating conditions increase the risk of premature wear of the product, especially those parts exposed to the direct heat of the fire (e.g. combustion chamber), the original condition of which can undergo modifications and deterioration which, among other things, could generate noise during operation of the unit due to mechanical expansion.

The manufacturer will not be held liable if the above information is ignored.

2.1 REVISIONS TO THE PUBLICATION

The content of this manual is strictly technical and the property of CADEL S.r.l.

No part of this manual may be translated into other languages, adapted and/or reproduced, even in part, in other mechanical and/or electronic form or media, for photocopies, recordings or other, without the prior written authorisation of CADEL S.r.l.

The company reserves the right to make changes to the product at any time without prior notice. The owner company reserves its rights according to law.

2.2 CARE OF THE MANUAL AND HOW TO CONSULT IT

- Take care of this manual and store it in an easily and quickly accessible place.
- Should this manual be lost or destroyed, request a copy from your retailer or directly from the authorised Technical assistance department. It can also be downloaded from the company's website.
- **"Bold text"** requires special attention.



3 SAFETY REQUIREMENTS



- Installation, electrical connection, functional verification and maintenance must only be performed by qualified or authorised personnel.
- Live electrical parts: disconnect the product from the 230V power supply before performing any maintenance operation. Only power the product after completing assembly.
- Special maintenance must only be performed by authorised and qualified personnel.
- All local regulations, including those referring to national European standards, must be respected during appliance installation.
- The manufacturer declines any responsibility in case of installation which are not in compliance with current regulations, in case of a wrong room ventilation system, in case of an electric connection which is not in compliance with regulations and in case of a wrong use of the appliance.
- It is forbidden to install the stove in bedrooms, bathrooms and in rooms used for storing combustible materials and in one-room flats.
- The installation in one-room flats is allowed if they are in sealed chamber.
- In any case the stove must not be installed in rooms where it can get in touch with water or water splashes because this can cause burn hazards and short-circuit.
- Please check that the floor has an adequate load capacity. If the existing one does not satisfy this requirement, appropriate measure should be provided (for example a plate for distributing the load).
- For safety fire regulations the distances from flammable or sensible to heat objects (sofas, pieces of furniture, wooden covering, etc...) must be respected.
- If there are highly flammable objects (curtains, fitted carpet, etc...), all these distances must be further increased with 1 meter.
- If the floor is made of combustible material, we recommend using a protector made of incombustible material (steel, glass, etc.) that also protects the front part from any falling burnt particles during cleaning.
- The electrical cable must not get in touch with the fume exhaust pipe and nor with every other part of the stove.
- The user, or whoever is operating the product, must read and fully understand the contents of this installation and use guide before performing any operation. Errors or incorrect settings can cause hazardous conditions and/or poor operation.
- The type of fuel to use is only the pellets.
- Do not use the appliance as waste incinerator.
- Do not place laundry on the product to dry. Any clothes horses or similar objects must be kept at a safe distance from the product. Fire hazard.
- It is forbidden to operate the product with the door open or the glass broken.
- It is forbidden to modify the appliance without authorization.
- Do not use flammable liquids during the ignition (alcohol, petrol, oil, etc...).
- After a failed ignition the burning pot must be empty from the amassed pellets, before starting the stove up again.
- The pellet hopper must always be closed with its own lid.
- Before of every intervention leave the fire completely extinguish till the cooling and always disconnect the plug from the electric socket.
- This appliance can be used by children aged from 8 years and above and persons with reduced physical, sensory or mental capabilities or lack of experience and knowledge if they have been given supervision or instruction concerning use of the appliance in a safe way and understand the hazards involved. Children shall not play with the appliance. Cleaning and user maintenance shall not be made by children without supervision.
- Packaging are not toys and could cause suffocation or strangulation and other health hazards! People (children included) with reduced mobility, psychological diseases or without

experience and knowledge must be kept away from packaging. The stove **IS NOT** a toy.

- Children must be constantly overseen in order to assure that they do not play with the appliance.
- During its running, the stove reaches high temperatures: keep away children and animals and for your safety please use appropriate fireproof devices, such as heat-protecting gloves.
- The stove is equipped with a safety device that stops the feed screw immediately when the pellet loading door is opened. This safety device (standard EN 60335-2-102) prevents the user from coming into contact with the moving parts of the appliance.
- The chimney flue must be cleaned, since the soot and unburnt oil deposits reduce its section so blocking the draught. In great quantities they can flare up.
- If the pellets are of bad quality (if contains sizing agents, oils, varnishes, plastic remains or if it is mealy), deposits will form along pellets drop pipe during the running. When the stove is switched off, these remains could form little hot coals that rising along the pipe could reach the pellets on the hopper burning them and creating a thick and harmful smoke inside the room. Please always keep the hopper closed with its own lid. If the pipe is sooty, please clean it.
- In case it would be necessary to extinguish the fire emitted by the stove or by the chimney flue, use a fire-extinguisher or contact the firemen. **DO NOT** use water to extinguish the fire inside the burning pot.
- Remote control (if present): keep the batteries out of the reach of children, risk of swallowing. If swallowed, seek medical advice immediately.
- Pellets must not be fed manually into the burner - this wrong behaviour can generate an abnormal amount of unburned gas, with a risk of explosion in the chamber.

4 CAUTIONS - WARRANTY CONDITIONS

4.1 INFORMATION

- Please contact the retailer or qualified personnel for any information, problem or malfunction.
- Only use the fuel specified by the manufacturer.
- When the product is switched on for the first time, it is normal for it to emit smoke due to the paint heating up for the first time. Therefore make sure the room it is installed in is well-ventilated.
- Periodically check and empty the inspectionable parts of the smoke duct (e.g. Tee fitting caps)
- Have the smoke outlet system periodically checked and cleaned
- The product is not a cooking appliance.
- Always keep the cover of the fuel hopper closed.
- Store this installation and user manual with care as it must accompany the product for the duration of its useful life. If the product is sold or transferred to another user, always ensure the manual is also handed over.

4.2 INTENDED USE

The product only works with wood pellets and must be installed inside a room.

4.3 PRODUCT PERFORMANCE CHECKS.

All our products undergo ITT TESTS carried out by a notified third party laboratory (system 3) and in accordance with Regulation (EU) number 305/2011 "Construction products", according to standard EN 14785:2006 for household appliances and "Machinery Directive" EN 303-5 for boilers.

In the case of tests for any market surveillance or inspections by third parties, please consider the following warnings:

- To reach the declared performance levels, the product must perform an operating cycle of at least 6/8 hours beforehand.
- Set the average draught of the combustion fumes as specified in the "technical product features" table
- The type of pellets used must comply with the current EN ISO 17225-2 class A1 regulation. Fir pellets are usually used for certification.
- The amount of thermal energy can vary according to the length and calorific value of the fuel. This may require some adjustments (accessed from the user menu) to comply with the hourly consumption specified in the "technical product features" table. Using class A1 pellets guarantees a calorific value that is likely to be close to that used in the product certification; the size of the pellet grains can significantly affect hourly fuel loading and consequently performance; it is therefore suggested to use pellets with a 6 mm diameter and an average length of around 24 mm (avoid pellets that are too long or excessively crushed).

- With wood-burning appliances, the fuel must comply with the current EN ISO 17225-5 class A1 regulation. Check the correct moisture of the fuel, as it must be within the range of 12 - 20% (it is best if the moisture is close to 12%, as is normally used in certification). As the fuel moisture increases, different combustion air settings are required, which are implemented from the combustion air register, thereby modifying the mixture of primary and secondary air
- It is important to check the operation of devices that can affect performance (for example air fans or electric safety devices) in case of damage due to handling.
- Nominal performance has been obtained by setting the maximum flame power and room ventilation in **automatic mode**.

4.4 WARRANTY CONDITIONS

The duration, conditions and limitations of CADEL S.r.l. can be found on the guarantee card enclosed with the device.

The company guarantees the product, **with the exception of elements subject to normal wear** listed below, for a period of **2 (two) years** from the date of purchase attested by:

- a document to serve as proof of purchase (invoice and/or receipt) that shows the name of the vendor and the date on which the purchase was made;
- forwarding of the completed certificate of guarantee within 8 days of purchase.

Furthermore, the product must be installed and started by specialised personnel who must, where provided, issue a declaration of conformity of the plant and of the proper functioning of the product, for the warranty to be valid and effective.

We recommend testing the product before completion with the relative finishes (claddings, painting of walls, etc.).

Installations not meeting the current standards, improper use and lack of maintenance as expected by the manufacturer, void the product warranty.

The guarantee is valid on the condition that the instructions and warnings contained in the use and maintenance manual are observed, and therefore the product is used correctly.

The replacement of the entire system or the repair of one of its components does not extend the guarantee period, and the original expiry date remains unchanged.

The guarantee covers the replacement or free repair **of parts recognised as being faulty at source due to manufacturing defects**.

To benefit from the guarantee, in the event of a fault, the customer must have the guarantee certificate and present it with the proof of purchase document to the Technical Assistance Office.

The guarantee does not cover malfunctions and/or damage to the appliance that arise due to the following causes:

- Damage caused during transportation or relocation.
- All parts that develop faults due to negligence or improper use, incorrect maintenance, installation that does not comply with the manufacturer's instructions (always refer to the installation and use manual provided with the appliance).
- Incorrect dimensioning with regards to the use or faults in the installation or failure to adopt the necessary devices to guarantee proper execution.
- Improper overheating of the equipment, use of fuels not conforming to the types and quantities indicated in the instructions provided.
- Further damage caused by incorrect user interventions in an attempt to fix the initial fault.
- Worsening of the damage due to the continued use of the equipment by the user, once the defect has been noticed.
- In the presence of a boiler, any corrosions, incrustations or breaks caused by water flow, condensation, hardness or acidity of the water, improperly performed descaling treatments, lack of water, mud or limescale deposits.
- Inefficiency of chimneys, flues or parts of the plant affecting the equipment.
- Damage caused by tampering with the appliance, atmospheric agents, natural disasters, vandalism, electrical discharges, fires, faults in the electric and/or hydraulic system.
- Failure to have the stove cleaned on an annual basis by an authorised technician or qualified personnel will result in the loss of the warranty.

Also excluded from this guarantee are:

- Parts subject to normal wear such as gaskets, glass, claddings and cast iron grids, painted, chrome-plated or gilded parts, handles and electric cables, bulbs, indicator lights, knobs, all parts which can be removed from the hearth.
- Variations in colour of the painted or ceramic/serpentine parts and craquelure ceramics as they are natural characteristics of the material and product use.
- Masonry work.
- Plant parts (if present) not supplied by the manufacturer.

Any technical interventions on the product to eliminate the above-said defects and consequent damages must be agreed upon with the Technical Assistance Centre, who reserves the right to accept the relative appointment or not. However, said interventions will not be carried out under warranty but as technical assistance to be granted at part of any eventual and specific agreed condi-

tions and in accordance with the fee in force for the work to be carried out.

The user will also be charged for any costs incurred to remedy the incorrect technical interventions, tampering or damage to the appliance, not attributable to original faults.

Save for the legal or regulatory limits, the guarantee does not cover the containment of atmospheric and acoustic pollution.

The company declines all liability for any damage which may be caused, directly or indirectly, to persons, animals or objects as a consequence of non compliance with any prescription specified in the manual, especially warnings regarding installation, use and maintenance of the appliance.

5 SPARE PARTS

For each repair or adjustment which should be necessary, please contact the dealer where you purchased your stove or your nearest Technical Assistance Service, specifying:

- Appliance model
- Serial number
- Type of problem

Use only original spare parts which you can find at our Technical Assistance Services.

6 DISPOSAL OF MATERIALS

6.1 WARNINGS FOR THE CORRECT DISPOSAL OF THE PRODUCT

The owner is the sole party responsible for demolishing and disposing of the product. This must be performed in compliance with laws related to safety and environmental protection in force in his/her country.

At the end of its working life, the product must not be disposed of as urban waste.

It must be taken to a special differentiated waste collection centre set up by the local authorities or to a retailer that provides this service.

Separating and recycling prevents potential negative effects on the environment and health (often caused by inappropriately disposing of product parts). It also allows materials to be recovered in order to obtain significant savings in energy and resources.

The following table and the exploded view it refers to highlight the main components that can be found in the device and indications on how to separate and dispose of them correctly when no longer used.

More specifically, the electric and electronic components must be separated and disposed of in authorised centres, in compliance with the WEEE directive 2012/19/EU and the relative national transpositions.

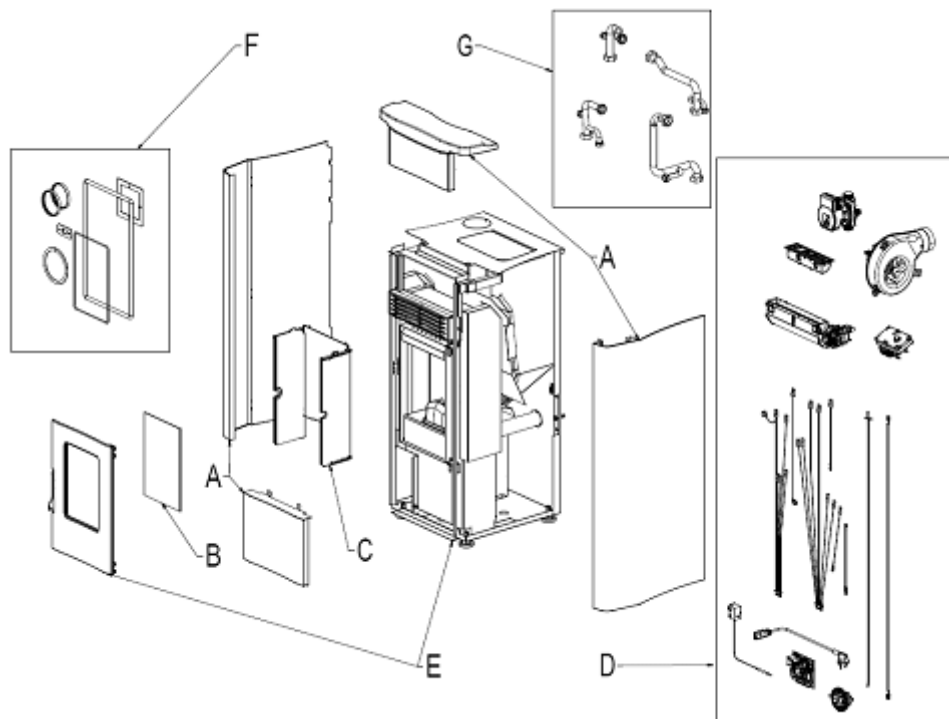

Fig. 1 - Exploded drawing

LEGENDA	WHERE TO DISPOSE	MATERIALS
A. OUTER CLADDING	If there is any, to be disposed of separately based on the material used:	Metal
		Glass
		Tiles or ceramics
		Stone
B. GLASS DOORS	If there is any, to be disposed of separately based on the material used:	Glass ceramic (fire door): to be disposed of with inert or mixed waste
		Tempered glass (oven door): to be disposed of with glass
C. INTERIOR CLADDING	If there is any, to be disposed of separately based on the material used:	Metal
		Refractory materials
		Insulating panels
		Vermiculite
		Insulation, vermiculite and refractory materials that have come into contact with flames or exhaust gases (dispose of in mixed waste)
D. ELECTRIC AND ELECTRONIC COMPONENTS	To be disposed of separately in authorised centres, as indicated in the WEEE directive 2012/19/EU and the relative national transposition.	Wiring, motors, fans, circulators, display panels, sensors ignition plug, electronic cards, batteries.
E. METAL STRUCTURE	To be disposed of separately with metal	-
F. COMPONENTS THAT CANNOT BE RECYCLED	To be disposed of with mixed waste	E.G.: Gaskets, rube piping, silicone or fibres, plastic.
G. HYDRAULIC COMPONENTS	Piping, fittings, expansion vessel, valves. If there are any, to be disposed of separately based on the material they are made of:	Copper
		Brass
		Stainless steel
		Other materials

6.2 INFORMATION FOR MANAGEMENT OF ELECTRIC AND ELECTRONIC APPLIANCE WASTE CONTAINING BATTERIES OR ACCUMULATORS

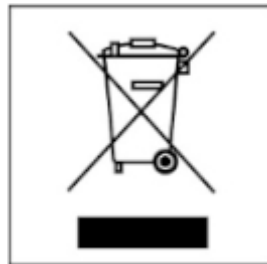

Fig. 2 - Waste disposal

This symbol, which is used on the product, batteries, accumulators or on the packaging or documents, means that at the end of its useful life, this product, the batteries and the accumulators included must not be collected, recycled or disposed of together with domestic waste.

Improper management of electric or electronic waste or batteries or accumulators can lead to the leakage of hazardous substances contained in the product. For the purpose of preventing damage to health or the environment, users are kindly asked to separate this equipment and/or batteries or accumulators included from other types of waste and to arrange for disposal by the municipal waste service. It is possible to ask your local dealer to collect the waste electric or electronic appliance under the conditions and following the methods provided by national laws transposing the Directive 2012/19/EU.







Separate waste collection and recycling of unused electric and electronic equipment, batteries and accumulators helps to save natural resources and to guarantee that this waste is processed in a manner that is safe for health and the environment.

For more information about how to collect electric and electronic equipment and appliances, batteries and accumulators, please contact your local Council or Public Authority competent to issue the relevant permits.

6.3 INSTRUCTIONS FOR PACKAGING DISPOSAL

The material that the appliance's packaging is made of must be managed correctly, in order to make collection, reuse, recovery and recycling easier, where possible.

The table below illustrates the possible components that the packaging is made of, and the relative instructions for correct disposal.

DESCRIPTION	CODE MATERIAL	SYMBOL	DIRECTIONS FOR COLLECTION
- WOOD BED - WOOD CAGE - WOOD PALLET	WOOD FOR 50		SORTED waste collection WOOD Check with the competent body on how to dispose of this packaging at the recycling depot
- CARDBOARD BOX - CARDBOARD CORNER - CARDBOARD SHEET	CORRUGATED CARDBOARD PAP 20		SORTED waste collection PAPER Check the instructions of the competent body
- APPLIANCE BAG - BAG OF ACCESSORIES - BUBBLE WRAP - PROTECTIVE SHEET - LABELS	POLYETHYLENE LD PE 04		SORTED waste collection PLASTIC Check the instructions of the competent body
- POLYSTYRENE - FOAM PEANUTS	POLYSTYRENE PS 6		SORTED waste collection PLASTIC Check the instructions of the competent body
- STRAP - TAPE	POLYPROPYLENE PP 5		SORTED waste collection PLASTIC Check the instructions of the competent body.
- SCREWS - STAPLES FOR STRAP - FASTENING BRACKET	IRON FE 40		SORTED waste collection METAL Check with the competent body on how to dispose of this packaging at the recycling depot

7 WIFI - BLUETOOTH CONNECTION

7.1 NAVEL STAND ALONE (OPTIONAL)



Procedure if only valid for models with NAVEL STAND ALONE Wi-Fi technology.



ATTENTION! Installation must **ONLY** be carried out by specialised personnel.

The manufacturer will not be held responsible for injury to persons or damage to property or in the event of failed operation.

The Wi-Fi module uses the domestic Wi-Fi network; ensure there is enough coverage in the place of installation.



N.B.: for stoves with a 3-button display, the programmable thermostat cannot be configured via the App.

Categories	Items	Specifications
Wi-Fi	Protocols	802.11 b/g/n (802.11n up to 150 Mbps) A-MPDU and A-MSDU aggregation and 0.4 μ s guard interval support
	Frequency range	2412 ~ 2484 MHz
Bluetooth	Protocols	Bluetooth v4.2 BR/EDR and BLE specification
	Radio	NZIF receiver with -97 dBm sensitivity
		Class-1, class-2 and class-3 transmitter
Audio	AFH CVSD and SBC	





Fig. 3 - NAVEL STAND ALONE module



Fig. 4 - App EASY CONNECT PLUS

The documentation for connecting the Wi-Fi and using the App are available online at the following addresses:

	https://www.cadelsrl.com/download-wi-fi/
	http://www.free-point.it/it/downloads/
	https://www.pegasoheating.com/it/documenti/

8 USE

8.1 INTRODUCTION

To have the best performance with the lowest consumption please follow the here described instructions.

- The lighting of the pellets occurs very easily if the installation is correct and if the chimney flue is efficient.
- **Switch on the stove at Power 5**, for at least 2 hours, in order to enable the materials which make up the boiler and the fireplace to adjust the inner springing stress. After 2 hours, the smell of paint and smoke will disappear.
- By using the stove the varnish inside the combustion chamber could be subjected to alterations. This occurrence can be attributed to different reasons: an excessive stove overheating, the presence of chemical agents in bad quality pellets, bad chimney draught, etc. Therefore varnish endurance in the combustion chamber cannot be guaranteed.



Oily plant waste and lacquers can cause smells and smoke during the first working hours: it is advisable to ventilate the room because they could be noxious to people and animals.



Set values from 1 to 5 are defined by the manufacturer and they can be changed only by an authorized technician.



The product will be subject to expansion and contraction during the ignition and cooling stages, therefore slight creaking noises may be heard. This is perfectly normal as the structure is made of laminated steel and must not be considered a defect.

8.2 CONTROL PANEL

The display allows you to dialogue with the stove by simply pressing a few buttons. A display with scrolling text and LED indicators inform the user about the stove's operating status.

Meaning of the buttons (see **Fig. 5**)

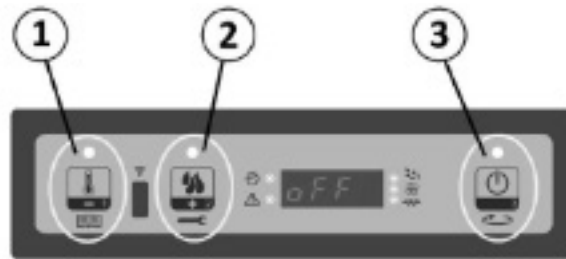

Fig. 5 - Display: 3 buttons

REFERENCE	BUTTON	DESCRIPTION	MODE	ACTION
1		Decreases temperature and power	TEMPERATURE SETTING	Decreases the value of the ambient temperature SETTING
			PROGRAMMING	Decreases the selected parameter
			POWER SETTING	Decreases the value of the operating power
2		Increases the temperature and power	TEMPERATURE SETTING	Increases the value of the ambient temperature SETTING
			PROGRAMMING	Increases the selected parameter
			POWER SETTING	Increases the value of the operating power
3		ON/OFF	WORK	Pressed for 2 seconds, it turns the stove on or off accordingly
			PROGRAMMING	Allows you to select the parameters to be programmed

Meaning of the LEDs that are on (see **Fig. 6**):

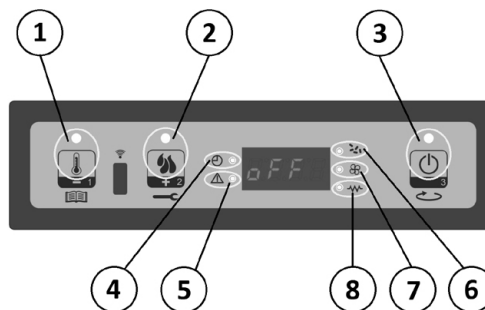









Fig. 6 - Display: LEDs on

REFERENCE	SYMBOL	DESCRIPTION	LED ON
1		AMBIENT SETTING	Ambient setting programming

REFERENCE	SYMBOL	DESCRIPTION	LED ON
2		POWER SETTING	Power setting programming
3		ON/OFF	Work status
4		CHRONO	Chrono is enabled
5		ALARM	Stove is in alarm
6		FEED SCREW ON	Feed screw moving
7		HEAT EXCHANGER	Heat exchanger on
8		SPARK PLUG	Ignition spark plug

8.3 USER MENU

The following table briefly describes the menu structure; this paragraph solely focuses on the selections available to the user.

LEVEL 1	LEVEL 2	LEVEL 3	VALUE
M1 Set orologio <i>M1-SEt cLoCk</i>			
	01 - Day of the week		M-T-W-T-F-S-S <i>Mond-tuES-uEdn-tHur-Frid-SAtu-Sund</i>
	02 - Clock hours <i>02-tiME cLoCk</i>		0-23
	03 - Clock minutes <i>03-MinutES cLoCk</i>		0-59
	04 - Clock day <i>04-dAy cLoCk</i>		1-31
	05 - Clock month <i>05-Month cLoCk</i>		1-12
	06 - Clock year		00-99
M2 - Chrono setting <i>M2-SEt cHrono</i>			
	M2-1 - Enable chrono <i>M2-1 cHrono EnAbLE</i>		
		01 - enable chrono <i>01-cHrono EnAbLE</i>	<i>on/off</i>
	M2-2 - Daily programming <i>M2-2 ProGrAM dAy</i>		
		01 - daily chrono <i>01-cHrono dAyLy</i>	<i>on/off</i>
		02 - start 1 day <i>02-StArt 1 dAyLy</i>	<i>off-0-23:50</i>

LEVEL 1	LEVEL 2	LEVEL 3	VALUE
		03 - stop 1 day <i>03-StoP 1 dAyLy</i>	<i>oFF-0-23:50</i>
		04 - start 2 day <i>04-StArt 2 dAyLy</i>	<i>oFF-0-23:50</i>
		05 - stop 2 day <i>05-StoP 2 dAyLy</i>	<i>oFF-0-23:50</i>
	M2-3 - Weekly programming <i>M2-3 -ProGrAM uEEK</i>		
		01 - week chrono <i>01-crono uEEKLy</i>	<i>on/oFF</i>
		02 - start Prg 1 <i>02-StArt PrG1</i>	<i>oFF-0-23:50</i>
		03 - stop Prg 1 <i>03-StoP PrG1</i>	<i>oFF-0-23:50</i>
		04 - Monday Prg1 <i>04-Mond PrG1</i>	<i>on/oFF</i>
		05 - Tuesday Prg 1 <i>05-tuES PrG1</i>	<i>on/oFF</i>
		06 - Wednesday Prg 1 <i>06-uEdn PrG1</i>	<i>on/oFF</i>
		07 - Thursday Prg1 <i>07-tHur PrG1</i>	<i>on/oFF</i>
		08 - Friday Prg 1 <i>08-Frid PrG1</i>	<i>on/oFF</i>
		09 - Saturday Prg 1 <i>09-SAtu PrG1</i>	<i>on/oFF</i>
		10 - Sunday Prg 1 <i>10-Sund PrG1</i>	<i>on/oFF</i>
		11 - start Prg 2 <i>11-StArt PrG2</i>	<i>oFF-0-23:50</i>
		12 - stop Prg 2 <i>12-StoP PrG2</i>	<i>oFF-0-23:50</i>
		13 - Monday Prg2 <i>13-Mond PrG2</i>	<i>on/oFF</i>
		14 - Tuesday Prg 2 <i>14-tuES PrG2</i>	<i>on/oFF</i>
		15 - Wednesday Prg 2 <i>15-uEdn PrG2</i>	<i>on/oFF</i>
		16 - Thursday Prg2 <i>16-tHur PrG2</i>	<i>on/oFF</i>
		17 - Friday Prg 2 <i>17-Frid PrG2</i>	<i>on/oFF</i>
		18 - Saturday Prg 2 <i>18-SAtu PrG2</i>	<i>on/oFF</i>
		19 - Sunday Prg 2 <i>19-Sund PrG2</i>	<i>on/oFF</i>
		20 - start Prg 3 <i>20-StArt PrG3</i>	<i>oFF-0-23:50</i>
		21 - stop Prg 3 <i>21-StoP PrG3</i>	<i>oFF-0-23:50</i>
		22 - Monday Prg3 <i>22-Mond PrG3</i>	<i>on/oFF</i>
		23 - Tuesday Prg 3 <i>23-tuES PrG3</i>	<i>on/oFF</i>
		24 - Wednesday Prg 3 <i>24-uEdn PrG3</i>	<i>on/oFF</i>
		25 - Thursday Prg3 <i>25-tHur PrG3</i>	<i>on/oFF</i>
		26 - Friday Prg 3 <i>26-Frid PrG3</i>	<i>on/oFF</i>

LEVEL 1	LEVEL 2	LEVEL 3	VALUE
		27 - Saturday PrG 3 27-SAtu PrG3	on/off
		28 - Sunday PrG 3 28-Sund PrG3	on/off
		29 - start PrG 4 29-StArt PrG4	off-0-23:50
		30 - stop PrG 4 30-StoP PrG4	off-0-23:50
		31 - Monday PrG4 31-Mond PrG4	on/off
		32 - Tuesday PrG 4 32-tuES PrG4	on/off
		33 - Wednesday PrG 4 33-uEdn PrG4	on/off
		34 - Thursday PrG4 34-tHur PrG4	on/off
		35 - Friday PrG 4 35-Frid PrG4	on/off
		36 - Saturday PrG 4 36-SAtu PrG4	on/off
		37 - Sunday PrG 4 37-Sund PrG4	on/off
	M2-4 - Weekend program M2-4-ProGrAM u-End		
		01 - weekend chrono 01-cHrono uEEK End	on/off
		02 - start weekend 1 02-StArt 1 uEEK End	off-0-23:50
		03 - stop weekend 1 03-StoP 1 uEEK End	off-0-23:50
		04 - start weekend 2 04-StArt 2 uEEK End	off-0-23:50
		05 - stop weekend 2 05-StoP 2 uEEK End	off-0-23:50
	M2-5 - Exit M2-5-ESCAPE		set
M3 - Choose language M3-LAnGuAGE			
	01 - Italian 01-LinG itA		set
	02 - English 02-LinG EnG		set
	03 - French 03-LinG FrE		set
	04 - German 04-LinG dEu		set
	05 - Spanish 05-LinG SPA		set
	06 - Portuguese 06-LinG Por		set
M4 - Stand-by M4-StAnd-by			
	01 - Stand - by 01-StAnd-by		on/off
M5 - Buzzer M5 buCCEr			
	01 - Buzzer 01-buCCEr		on/off
M6 - First load M6 LoAd initial			

LEVEL 1	LEVEL 2	LEVEL 3	VALUE
	01 - First load <i>01-LoAd initiAL</i>		90"
M7 - Stove status <i>M7 StAtE StoVE</i>			
	01 - Stove status <i>01-StAtE StoVE</i>		
		01 - Feed screw status	info
		02 - T minutes	info
		03 - Thermostat status	info
		04 - Flue gas status	info
		05 - Flue gas extraction rpm status	info
M8 - Engineer settings <i>M8 SEt tEChnic</i>			
	01 - Password <i>01-KEy AccESS</i>		set
M9 - Pellet type <i>M9 tyPE PELLEt</i>			
	01 - Loading pellets <i>01-Pr 54 LoAd PELLEt</i>		da -9 a +9
MA - Flue type <i>MA tyPE cHiMnEy</i>			
	01 - Flue extractor <i>01-Pr 55 SMoKE cHiMnEy</i>		da -9 a +9
MB - Exit <i>Mb ESCAPE</i>			
	01 - Exit <i>01-ESCAPE</i>		set

8.3.1 Menu M1 - CLOCK SETTING

Set the current time and date. The board has a lithium battery that assures the internal clock life of more than 3-5 years. Press the P1 button for 2 seconds to access the general programming menus. Pressing P1 (decreases) or P2 (increases) selects item M1, and **M1 Set cLock** will scroll "M1-SEt cLoCk" (see Fig. 7).



Fig. 7 - Display: M1

8.3.2 Menu M2 - CHRONO SETTING

Submenu M2-1 Enable chrono

The menu shown on the **M2 - 1 chrono setting** "Chrono EnABLE" display allows you to globally enable and disable all the chronothermostat functions. Enable by pressing button P3 and then pressing P1 or P2 for the On or Off section. Confirm with the P3 button (see Fig. 8).



Fig. 8 - Display: enables

Submenu M2 - 2 - Day program

After selecting the **M2 - 2 day program "ProGrAM dAy"** menu, using the P3 button you will scroll through the various daily chrono programming parameters, including enabling it (see **Fig. 9**).



Fig. 9 - Display: crono

Two operating ranges can be set, the first with **START1 Day "StArt 1 dAyLy"** and **STOP1 Day "StoP 1 dAyLy"**, the second with **START2 Day "StArt 2 dAyLy"** and **STOP2 Day "StoP 2 dAyLy"**, delimited by the times set according to the table below where the OFF setting indicates the clock to ignore the command. Use buttons P1 (decreases) and P2 (increases) to vary, and P3 to confirm.

DAY PROGRAM			
<i>MENU LEVEL</i>	<i>SELECTION</i>	<i>MEANING</i>	<i>POSSIBLE VALUES</i>
M2-2-01	cHrono dAyLy	Enables the daily chrono	ON/OFF
M2-2-02	StArt 1 dAyLy	activation time	OFF-0-23:50
M2-2-03	StoP 1 dAyLy	deactivation time	OFF-0-23:50
M2-2-04	StArt 2 dAyLy	activation time	OFF-0-23:50
M2-2-05	StoP 2 dAyLy	deactivation time	OFF-0-23:50

Submenu M2 - 3 - weekly program

The **M2-3 Weekly Program "ProGrAM uEEK"** menu allows you to enable/disable and set the weekly chronothermostat functions. The weekly function has 4 independent programs. Furthermore, by setting OFF in the time field, the clock ignores the corresponding command.

The tables below summarise the weekly program function. Press the P3 button to access the next function and confirm the value. It is possible to exit the menu by pressing the P3 button for long.

ENABLING WEEKLY CHRONO			
<i>MENU LEVEL</i>	<i>SELECTION</i>	<i>MEANING</i>	<i>POSSIBLE VALUES</i>
M2-3-01	crono uEEKLy	Enables the weekly chrono	ON/OFF

PROGRAM 1			
<i>MENU LEVEL</i>	<i>SELECTION</i>	<i>MEANING</i>	<i>POSSIBLE VALUES</i>
M2-3-02	StArt PrG1	activation time	OFF-0-23:50
M2-3-03	StoP PrG1	deactivation time	OFF-0-23:50
M2-3-04	Mond PrG1	reference day	on/off
M2-3-05	tuES PrG1		on/off
M2-3-06	uEdn PrG1		on/off
M2-3-07	tHur PrG1		on/off
M2-3-08	Frid PrG1		on/off
M2-3-09	SAtu PrG1		on/off
M2-3-10	Sund PrG1		on/off

PROGRAM 2			
<i>MENU LEVEL</i>	<i>SELECTION</i>	<i>MEANING</i>	<i>POSSIBLE VALUES</i>
M2-3-11	StArt PrG2	activation time	off-0-23:50
M2-3-12	StoP PrG2	deactivation time	off-0-23:50
M2-3-13	Mond PrG2	reference day	on/off
M2-3-14	tuES PrG2		on/off
M2-3-15	uEdn PrG2		on/off
M2-3-16	tHur PrG2		on/off
M2-3-17	Frid PrG2		on/off
M2-3-18	SAtu PrG2		on/off
M2-3-19	Sund PrG2		on/off

PROGRAM 3			
MENU LEVEL	SELECTION	MEANING	POSSIBLE VALUES
M2-3-20	StArt PrG3	activation time	off-0-23:50
M2-3-21	StoP PrG3	deactivation time	off-0-23:50
M2-3-22	Mond PrG3	reference day	on/off
M2-3-23	tuES PrG3		on/off
M2-3-24	uEdn PrG3		on/off
M2-3-25	tHur PrG3		on/off
M2-3-26	Frid PrG3		on/off
M2-3-27	SAtu PrG3		on/off
M2-3-28	Sund PrG3		on/off

PROGRAM 4			
MENU LEVEL	SELECTION	MEANING	POSSIBLE VALUES
M2-3-29	StArt PrG4	activation time	off-0-23:50
M2-3-30	StoP PrG4	deactivation time	off-0-23:50
M2-3-31	Mond PrG4	reference day	on/off
M2-3-32	tuES PrG4		on/off
M2-3-33	uEdn PrG4		on/off
M2-3-34	tHur PrG4		on/off
M2-3-35	Frid PrG4		on/off
M2-3-36	SAtu PrG4		on/off
M2-3-37	Sund PrG4		on/off

Submenu M2 - 4 - weekend program

Allows you to enable/disable and set the weekend chronothermostat functions (day 6 and 7, i.e. Saturday and Sunday). Enable by pressing the P3 button in **01 - the weekend chrono** "cHrono uEEK End" setting and set "on" using the P1 (decreases) or P2 (increases) button. Setting the [CS:Grassetto:02 - Start 1 weekend[2:]] "StArt 1 uEEK End" and **03 - Stop1 weekend times** "StoP 1 uEEK End" sets the operating period for **Saturday**, "SAtu" whereas **04 - Start 2 weekend** "StArt 2 uEEK End" and **05 - Stop 2 weekend** "StoP 2 uEEK End" sets the stove operation for **Sunday** "Sund".

WEEK-END PROGRAM			
MENU LEVEL	SELECTION	MEANING	POSSIBLE VALUES
M2-4-01	cHrono uEEK End	Enables the weekend chrono	on/off
M2-4-02	StArt 1 uEEK End	activation time	off-0-23:50
M2-4-03	StoP 1 uEEK End	deactivation time	off-0-23:50
M2-4-04	StArt 2 uEEK End	activation time	off-0-23:50
M2-4-05	StoP 2 uEEK End	deactivation time	off-0-23:50

8.3.3 Menu M3 - LANGUAGE SELECTION

Allows you to select the dialogue language from those available (see vedi **Fig. 10**). To switch to the next language press P2 (increases), to go backwards press P1 (decreases), and to confirm press P3.



Fig. 10 - Display: language

8.3.4 Menu M4 - STAND-BY

Allows you to enable or disable the M4 - Stand-by "M4 StAnd-by" mode (see 14366). Once the M4 menu has been selected with the P3 button, press P1 (decreases) or P2 (increases) to change the state from ON to OFF and viceversa.



Fig. 11 - Display: stand-by

8.3.5 Menu M5 - BUZZER

Allows you to enable or disable the buzzer of the controller when alarms are indicated (see Fig. 12). Enable or disable with buttons P1 or P2, and confirm with P3.



Fig. 12 - Display: buzzer

8.3.6 Menu M6 - FIRST LOAD

This function is only available when the stove is OFF and allows the feed screw to be loaded with the first start-up of the stove, when the pellet tank is empty. After selecting menu M6, the message **Press More** "PrESS MorE" will scroll on the display (see Fig. 13). Then press P2 (increases). The flue gas fan turns on at maximum speed, the feed screw turns on (feed screw LED on) and they remain until the time indicated on the display elapses (see Fig. 14), or until button P3 is pressed.



Fig. 13 - Display: press more



Fig. 14 - Display: time left

8.3.7 Menu M7 - STOVE STATUS

Once in menu M7, after pressing button P3, the status of some variables scrolls on the display while the stove is working. The table below shows an example of the display and its meaning of these values.

STATUS DISPLAYED	MEANING
3,1"	Pellet loading feed screw status
52'	Time out
Toff	Thermostat status
106°	Flue Gas Temperature
1490	Flue gas extraction speed

8.3.8 Menu M8 - ENGINEER SETTINGS

This menu item is reserved for the stove installer. After entering the password (see Fig. 15) it allows you to set the various operating parameters of the stove using buttons P1 (decreases) and P2 (increases).



Fig. 15 - Display: key

8.3.9 Menu M9 - PELLET TYPE

It allows you to adjust the quality of combustion and the flame based on the fuel quality or draft of the flue (see **Fig. 16**). Thanks to this adjustment the fuel supply in the burn pot may be modified by an amount between -18% and +18% (value from -9 = -18% to +9 = +18%).



Fig. 16 - Display: pellet type

8.3.10 Menu MA - FLUE TYPE

The RPM of the flue gas extractor fan may be changed as a percentage to counter some draft issues or reduce extraction in case of flues with excess draft (see **Fig. 17**).

The flue gas extractor speed adjustment can vary between -18% and +18% (value from -9 = -18% to +9 = +18%).



Fig. 17 - Display: flue type

8.3.11 Menu MB - EXIT

Selecting this item by pressing button P3 (see **Fig. 18**), exits the menu and returns to the previous state.



Fig. 18 - Display: exit

8.4 STOVE SWITCH-ON

We remind you that the first start-up must be carried out by skilled and authorised technical personnel who check that everything is installed according to the regulations in force and verifies its functionality.

- If inside the combustion chamber there are booklets, manuals, etc. remove them.
- Check that the door is closed properly.
- Check that the plug is inserted into the socket.
- Before turning the stove on, make sure that the burn pot is clean.

Start up the stove by pressing button P3 for a few seconds so that **Turn on "StArt"** is displayed. In these conditions, the stove goes into the preheating state: the spark plugs go on (visible from the spark plug LED) together with the flue gas extraction fan. Any anomalies during the ignition phase are shown on the display and the stove goes into alarm status.

The pellet loading phase starts after about 1 minute, and the display shows the message **Pellet loading "LoAd PELLEt"** and the ON/OFF LED flashes intermittently. In the first phase, the feed screw loads the pellet into the burn pot. After the temperature of the flue gas has reached and exceeded the contained value, the system goes into ignition mode and **Fire present "FLAME LiGht"** appears on the display and the ON/OFF LED flashes.

When the flue gas temperature has reached and exceeded the intended value, the stove goes into the normal operating mode. The display shows the word **Work "uorK"** and the ON/OFF LED is lit.

The power can be set by keeping button P2 pressed and the room temperature can be set by pressing button P1.

At set intervals, an automatic burn pot cleaning is performed in order to prevent dash from accumulating. On the display you will see **Cleaning fire-pot "cLEAninG FirE-Pot"**.

If this function lasts for a few seconds, it is NOT an alarm.



Fig. 19 - Display

8.5 FAILED IGNITION

If the pellets do not burn, the failed ignition will be indicated by the alarm **AL 5 FAILED IGNITION** "AL 5 ALAr no LiGhtin". If the room temperature is lower than 10°C, the plug is not able to bear the ignition stage. To support it please insert some pellets in the burning pot and a piece of burning firelighter igniter material on the pellets (for example firelighters cubes). Too much pellets in the burning pot, or humid pellet, or sooty burning pot make ignition difficult and create dense white smoke which is harmful to health and can cause explosions on the combustion chamber. It is therefore necessary not to stand in front of the stove during ignition stage if dense white smoke is present.



If after some months the flame appears weak and/or orange colored or the glass tends to blackens and the burning pot to become encrusted, clean the stove, clean the fume conduit and the chimney flue.

8.6 POWER FAILURE

After a **Black-out** "bLAc-out" lower than 5 seconds, the stove turns back to the power which was settled. After a **Black-out** "bLAc-out" of more than 5 seconds, the stove enters the **COOLING WAIT** "uAit coolinG" phase. Completed this phase, it starts automatically up with the different phases (see **STOVE SWITCH-ON** a pag. 20).

8.7 TEMPERATURE SETTING

Change the room temperature by simply pressing button **P1**. The display shows the set room temperature (**temperature SETTING**). Therefore, the value can be changed by pressing buttons **P1 (decreases)** and **P2 (increases)**. After about 5 seconds the value is saved and the display returns to normal display, or exit by pressing **P3**.

8.8 POWER SETTING

Change the set power by simply pressing button **P2**. The display shows the set power (power SETTING). Therefore, the value can be changed by pressing buttons **P1 (decreases)** and **P2 (increases)**. After about 5 seconds the value is saved and the display returns to normal display, or exit by pressing **P3**.

NOTE: when the room temperature has reached the set value, the heating power of the stove is automatically brought to the minimum value. In these conditions, the display shows the message **Modulate** "ModuLAt".

If the room temperature drops below the set temperature, the stove returns to "**Work**" "uorK" mode at the previously set power.

8.9 SWITCHING OFF

Switch the stove off by simply pressing and holding down button **P3**. Pul-Finale "**cLEAninG SPEEd**" appears on the display. After a certain time, the stove switches off, and **Off** "oFF" is displayed.

8.10 CONNECTION TO THE EXTERNAL THERMOSTAT

The stove works through a thermostat probe placed in its inner. If you desire, the stove can be connected to an external room thermostat. This operation must be executed by an authorized technician.

9 FUEL

9.1 FUEL

- Use top-quality pellets because they have influence in the calorific value and in ash remains.
- Not adequate pellets cause a bad combustion, a frequent burning pot obstruction and exhaust conduits obstruction. Further it decreases the calorific value, soils the glass and increases consumptions and ash and unburnt granules quantity.



Humid pellets cause a bad combustion and running, so please assure you that they are stored in dry places and far at least one meter from the stove and/or any other source of heat.

- It is advisable to try different type of pellets available on the market and to choose that which gives the best performance.
- Pellets of variable quality and size are available on the market: the smaller the pellet, the greater the fuel supply, resulting in poor combustion



Depending on the type of pellets it could be necessary a parameters adjustment, please contact an Authorized Assistance Service.

The main quality certifications for pellets currently available on the European market guarantee that the fuel complies with class A1/A2 according to ISO 17225-2. These certifications include, for example, ENPlus, DINplus, Ö-Norm M7135, and specifically assure that the following characteristics are complied with:

- calorific value: 4.6 - 5.3 kWh/kg.
- Water content: $\leq 10\%$ of the weight.
- Percentage of ash: max 1.2% of the weight (A1 less than 0.7%).
- Diameter: $6\pm 1/8\pm 1$ mm.
- Length: 3-40 mm.
- Content: 100% untreated wood without the addition of binding agents.



The company recommends using certified fuel for its products (ENPlus A1, DINplus, Ö-Norm M7135).

The use of pellets that do not comply with the characteristics specified previously may compromise the operation of your product and therefore invalidate the warranty and product liability.

9.2 PELLET SUPPLY



Fig. 20 - Wrong opening of the pellets bag



Fig. 21 - Right opening of the pellets bag

It is necessary to avoid to fill the hopper with the pellet when the stove is running.

- Do not get the bag of pellet in contact with hot stove surfaces.
- Do not empty the hopper with remaining fuels (unburnt pellet) from the burning pot coming from ignition waster.

9.3 PELLET REFUELLING TIMER

This stove is equipped with a safety timer that activates after the pellet hopper door has been open for **90 seconds** during reloading (see **Fig. 22** and **Fig. 24**). After 90 seconds, the stove goes into "A05" depression alarm and proceeds to switch off. Wait until it switches off, then light it again.



Fig. 22 - Door open



Fig. 23 - deteriorated gasket

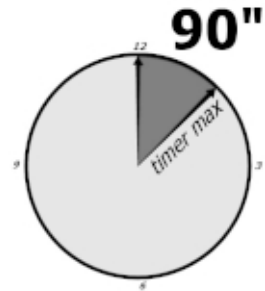

Fig. 24 - Timer: 90 seconds



To operate correctly, the stove must work with the pellet hopper door always closed; should it remain open for more than 90 seconds, the stove switches off.

- The loading system stops when the tank door is opened.



Before closing the lid, make sure there are no pellets below the gasket. Pellets deteriorate the gasket and eliminate its airtight sealing. (vedi Fig. 23)

10 VENTILATION

- The stove is endowed with a ventilation system.
- The air blown from fans keeps the appliance at a low temperature range in order to avoid high stresses to the materials which make it up.
- Do not cover the hot air outlet slits with any object to avoid stove's overheating!
- The stove is not suitable for food cooking.



Fig. 25 - Do not cover air slits

11 REMOTE CONTROL (OPTIONAL)

- The stove can be operated through a remote control (optional)
- Operation requires 1 CR 2025 (3Volt) Lithium battery
- Operating temperature 0 °C / 50 °C
- 38 khz infrared signal



Used batteries contain metals which are harmful for the environment; they must therefore be disposed of separately in the special containers.



Fig. 26 - Remote control

LEGEND	Fig. 26
Button 1	Increase the desired temperature (5÷35 °C)
Button 2	Decrease the desired temperature (35÷5 °C)
Button 3	On / off
Button 4	Menu
Button 5	Decrease the power level from 5 to 1
Button 6	Increase the power level from 1 to 5

12 SAFETY DEVICES AND ALARMS

The product is supplied with the following safety devices

12.1 PRESSURE SWITCH

- It controls pressure in the fume duct. It blocks the pellet feed screw in the following instances:
- clogged exhaust
- Significant negative (wind)
- clogged fume passages
- open pellet loading tank
- open fire door or worn/broken gaskets.
- see SMOKE RPM VARIATION User Manual

12.2 SMOKE TEMPERATURE PROBE

Detects the temperature of the smoke, thereby enabling start-up or stopping the product when the temperature drops below the preset value.

12.3 CONTACT THERMOSTAT IN THE FUEL HOPPER

If the temperature exceeds the preset safety level, it immediately shuts down boiler operation.

12.4 ELECTRICAL SAFETY

The product is protected against sudden current surges by a main fuse in the power supply panel on the rear part of the product. Other fuses that protect the electronic boards are found on the latter.

12.5 SMOKE FAN

If the fan stops, the electronic board promptly shuts off the pellets supply and an alarm message is displayed.

12.6 GEAR MOTOR

If the gear motor stops, the boiler will continue to run until the flame goes out due to lack of fuel and until a minimum level of cooling is reached.

12.7 TEMPORARY POWER CUT

If the power cut lasts less than 10" the boiler returns to its previous operating status; if it lasts more it carries out a cooling/restart cycle.

12.8 FAILED START-UP

If during ignition no flame develops, the boiler will go into alarm condition.

12.9 BLACKOUT WITH THE BOILER ON

In the event of a power cut **BLACK-OUT** "blAc-out" the boiler behaves as follows:

- Blackout below 5": it returns to its operation in progress;
- In the event of a power cut that lasts over 5" with the boiler on or in the start-up stage, when the boiler is powered again it goes back to the previous operating condition with the following procedure:
 - 1) It performs a cooling phase to the maximum.
 - 2) Performs a new ignition.

The display will show the message **Al 1 alar al 1 Blac-out** "AL 1 bLAc-out" (see **Fig. 27**) and the stove will shut down.



Fig. 27 - Display: AL 1

12.10 FLUE GAS TEMPERATURE PROBE ALARM

Occurs when the flue gas probe is faulty. The stove goes into the alarm state and the alarms LED lights up (alarm LED on).

The stove display will show the message **Al 2 alar al 2 Flue gas probe** "AL 2 ALAr AL2 ProBE EXHAuSt" (see **Fig. 28**) and will shut down.



Fig. 28 - Display: AL 2

12.11 FLUE GAS OVERTEMPERATURE ALARM

Occurs when the flue gas probe detects a temperature higher than a fixed set value that cannot be changed via parameter.

The display will show the message **Al 3 alar al 3 Hot flue gas** "AL 3 ALAr AL3 Hot EXHAuSt" as in (see **Fig. 29**) and the stove will shut down.



Fig. 29 - Display: AL 3

12.12 FAULTY FLUE GAS ENCODER ALARM

It occurs if there is a fault in the flue gas fan.

The stove goes into the alarm status and the message **Al 4 alar al 4 Faulty extractor** "AL 4 ALAr AL4 FAn FaiLurE" will scroll on the display (see **Fig. 30**).



Fig. 30 - Display: AL 4

12.13 FAILED IGNITION ALARM

It occurs when the ignition phase fails.

The message **Al 5 alar al 5 Failed ignition** "AL 5 ALAr no LiGHtin" scrolls on the display and the stove goes into alarm status (see Fig. 31).



Fig. 31 - Display: AL 5

12.14 NO PELLET ALARM

It occurs when in the working phase, the flue gas temperature drops below a specific fixed parameter.

The message **Al 6 alar No pellet** "AL 6 ALAr MAnCAno PELLEt" scrolls on the display and the stove goes into alarm status (see Fig. 32).



Fig. 32 - Display: AL 6

12.15 THERMAL SAFETY OVERHEATING ALARM

Occurs when the general safety thermostat detects a temperature above the trigger threshold. The thermostat triggers and turns off the feed screw, indicating the alarm status (alarm LED on).

The display will show the message **Al 7 alar 7 Thermal safety** "AL 7 ALAr SAFETy tHErMAL" (see Fig. 33) and the stove will shut down.



Fig. 33 - Display: AL 7

12.16 NO NEGATIVE PRESSURE ALARM

It occurs when the external pressure switch component detects a pressure/negative pressure lower than the trigger threshold. The pressure switch triggers and turns off the feed screw, indicating the alarm status (alarm LED on).









The display will show the message **Al 8 alar al 8 No Negative Pressure** "AL 8 ALAr FAiLurE dEPRESS" (see Fig. 34) and the stove will shut down.

























Fig. 34 - Display: AL 8

12.17 ALARM ALERTS

Whenever an operating condition other than that designed for the regular operation of the boiler occurs, there is an alarm condition. The control panel gives information on the reason of the alarm in progress.

ALARM	CAUSE	SOLUTION	INTERVENTION
AL 1 - BLACK OUT	Power cut during ignition phase.	Clean the burning pot and switch the stove on again.	
AL 2 - EXHAUST PROBE	Disconnected fume temperature probe	Have the stove checked.	
	Faulty fume temperature probe	Replace the fume probe.	
AL 3 - HOT EXHAUST	Faulty fume probe	Replace the fume probe.	
	Faulty mother board	Replace the electronic board.	
	The exchanger fan does not work	Replace the ambient fan.	
	Too high pellet drop value	Adjust the pellet loading.	
AL 4 - FAN FAILURE	Faulty protection fuse of the fume fan	Replace the fuse (1,25A).	
	Faulty fume fan	The pellets can burn also thanks to the chimney flue depression and without the aid of the fume fan. Have the fume fan replaced immediately. It can be noxious to health to let the stove running without fume fan.	

ALARM	CAUSE	SOLUTION	INTERVENTION
AL 5 - FAILED IGNITION	Empty hopper	Fill the hopper.	
	The burning pot has not been cleaned	Clean the burning pot.	
	The ignition threshold has not been reached	Clean the burning pot and switch the stove on again.	
	Faulty ignition plug	Replace the ignitor resistance.	
	Too sever external temperature	Start the stove up again.	
	Humid pellet	The pellets must be stored in a dry place. Please check it.	
	Blocked thermal probe	Replace the thermal probe.	
	Faulty mother board	Replace the mother board.	
AL 6 - NO PELLETT	Empty hopper	Full the hopper.	
AL 7 - THERMAL SAFETY	Boiler overheating	Let the stove cooling. (If the problem persits please call an Authorized Technician).	
	The ambient exchanger fan does not work	Replace the ambient fan.	
	Temporary power cut	The lack of tension during the running implies the overheating of the boiler and the intervention of the manula reset thermostat. Let the stove cooling, reset and start the stove up again.	
	Faulty manual reset thermostat	Replace the manual reset thermostat.	
	Faulty mother board	Replace the mother board.	

ALARM	CAUSE	SOLUTION	INTERVENTION
AL 8 - FAILURE DEPRESS	Obstructed exhaust	The exhaust chimney is partially or totally obstructed. Call an expert stove-repairer who executes a check from the exhaust up to the chimney pot.	
	Fume fan out of order	The pellet can burn also thanks to the chimney flue depression without the aid of the fan. Have the fume fan immediately replaced. It can be noxious to health to let the stove running without fan.	
	Obstructed connecting nozzle	Clean the connecting nozzle.	
	Faulty pressostat	Replace the pressostat.	
	Faulty electronic board	Replace the mother board.	
	Extreme chimney length	Contact an expert stove repairer and check that the exhaust chimney is in compliance with regulations	
	Advers weather conditions	In case of strong wind there can be a negative pressure to the chimney. Check and switch the stove on again.	
	The fire door is not correctly closed	Close the fire door correctly and check if the gaskets are broken.	
	Fire door microswitch faulty or out of order	Replace the fire door microswitch.	

12.18 ALARM RESET

To reset the alarm you must keep the P3 button pressed for some time. The stove performs a check to determine whether the warning cause is still present.

If this is the case, the warning will be shown again, otherwise the stove will switch to the **OFF** "OFF" position.

If the warning is still present, contact a service centre.

13 ROUTINE MAINTENANCE

13.1 INTRODUCTION

For a long working life of the stove, have a periodic cleaning of the stove as described in the following paragraphs.

- Fume outlet pipes (fume conduit + chimney flue + chimney pot) must always be cleaned, scrubbed and checked by an authorized technician in compliance with local regulations, with the instructions of the manufacturer and those of your insurance company.
- If there are no local regulations and no instruction from your insurance company, it is necessary to have your fume pipe, chimney flue and chimney pot cleaned at least once a year.
- It is also necessary to have the combustion chamber, motors and fans cleaned and to have the gaskets and the electrical elements checked at least once a year.



All these operations must be planned in time with your Authorized Technical Assistance Service.

- After a long ineffective time, before turning on the stove check if there are obstructions in the fume exhaust.
- If the stove had been using continuously and intensely, the whole system (chimney included), must be cleaned and checked more frequently.
- In case of replacement of damaged pieces please ask for the original spare part at the Authorized Retailer.

13.2 BEFORE EACH START-UP

Clean the ash and any deposits in the brazier that could clog the air passage holes.

If the pellets in the hopper finish, unburned pellets may accumulate in the brazier. Always empty the residue in the brazier before starting up.

Check that there is no excessive ash accumulated under the burning pot compartment. If it exceeds 2 cm of height, we recommend sucking it.



REMEMBER THAT ONLY A CORRECTLY POSITIONED AND CLEAN BRAZIER CAN GUARANTEE START-UP AND OPTIMAL OPERATION OF YOUR PELLET PRODUCT.

For the brazier to be cleaned properly, remove it from its housing completely and thoroughly clean all the holes and the grate on the bottom.

If good quality pellets are used, you will normally only need to use a brush to restore the optimal operating conditions of the component.

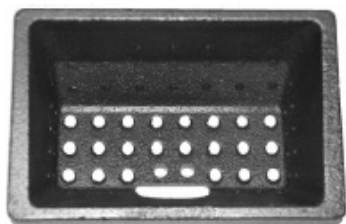

Fig. 35 - Example of cleanly brazier

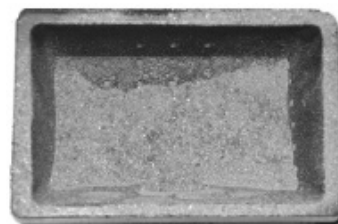

Fig. 36 - Example of dirty brazier

13.3 BURNING POT AND ASH TRAY CLEANING

- Open the door.



Fig. 37 - Burning pot extraction



Fig. 38 - Burning pot cleaning

- Extract the burning pot (see **Fig. 37**) from its seat and empty it from the ash.
- If necessary clean with a pointed object the holes obstructed by encrustations (see **Fig. 38**).



Fig. 39 - Burning pot box cleaning



Fig. 40 - Cleaning with a brush

- Clean and drain away the burning pot box and ash tray box from ash which has accumulated in its inner (see **Fig. 39**).
- Clean also the hole for pellet drop with a brush (see **Fig. 40**).
- The ash remains must be poured in a metal container with a sealed lid and this container must never get in touch with combustible materials (for example put on a wooden floor), as the inner ash keeps the embers firing for a long time.
- Only when the embers are off the ash could be poured in the organic waste.
- Pay attention if the flame becomes red colored, if it is weak or if black smoke creates in the inner: in this case the burning pot is encrusted and needs to be cleaned. If it is broken, it must be replaced.

13.4 HOPPER CLEANING

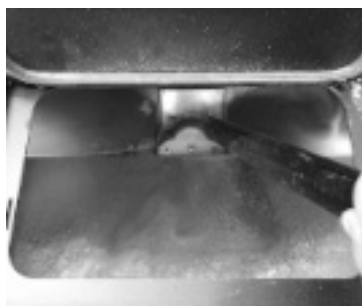

Fig. 41 - Hopper cleaning

Per each pellets supply, check the probable presence of meal, sawdust and other remanins on the hopper bottom. If present, they must be removed with the aid of a vacuum cleaner (see **Fig. 41**).

13.5 FUME PIPES ANNUAL CLEANING

Clean annually from soot with brushes.

The cleaning operation must be executed by a specialized stove-repairer who will provide for the cleaning of fume pipe, chimney flue and chimney pot. He will also check their efficiency and will release a written declaration of the safety of the appliance. This operation must be executed at least once a year.

13.6 GENERAL CLEANING

For cleaning external and inner parts of the stove do not use steel wools, muriatic acid or other corrosive and abrasive materials.

13.7 CLEANING OF PAINTED METAL PANELS

To clean painted metal panels use a soft cloth. Do not use degreasant agents like alcool, diluents, acetone, gasoline because these could irremediably damage the varnish.

13.8 CLEANING OF CERAMIC AND STONE PANELS

Some stove models has an external lining made up of ceramic or stone. These pieces are handmade therefore they could inevitably present crazings, seedinesses, shadings.

To clean ceramic or stone panels use a soft and dry cloth. If using any cleaners this will seep through the crazings putting them in evidence.

13.9 GASKET REPLACEMENT

In case of deterioration of fire door, hopper or fume chamber gaskets, it is necessary to replace them by an authorized technician in order to guarantee the good running of the stove.



Use exclusively original spare parts.

13.10 GLASS CLEANING

The glass-ceramic of the fire door is able to stand till 700°C but not to thermal shocks.

The probable cleaning with usual sale product for glass cleaning must be effected at cool glass in order to avoid explosions.



You should clean the fire door glass every day!

13.11 SHUTDOWN (END OF SEASON)

At the end of each season, before switching the product off, it is recommended to remove all the pellets from the hopper with a vacuum cleaner with a long pipe.

We recommend removing the unused pellets from the hopper because they can retain moisture. Disconnect any combustion air ducting that can lead to moisture inside the combustion chamber but, above all, ask the specialised technician to refresh the paint inside the combustion chamber with the special silicone spray paints (available at any store or Technical Assistance Centre) during the necessary annual end of season scheduled maintenance operations. This way the paint will protect the inner parts of the combustion chamber, blocking any type of oxidative process.

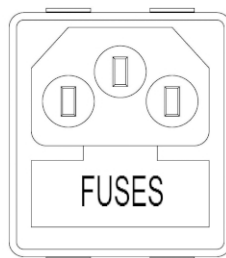

Fig. 42 - Shutter with fuses to remove

When not in use the appliance must be disconnected from the mains power supply. It is recommended to remove the power cable for additional safety, especially in the presence of children.

The service fuse may have to be replaced if the control panel display does not switch on.

There is a fusebox on the back of the product, near the power socket.

After removing the plugs from the power socket, open the fusebox cover with a screwdriver and replace the fuses if necessary (3.15 A delayed) - seek assistance from an authorised and qualified technician.

13.12 CHECKING THE INNER COMPONENTS



ATTENTION!

The internal electromechanical components must only be checked by qualified personnel whose technical expertise includes combustion and electricity.

We recommend for this yearly maintenance to be carried out (with a scheduled service contract). This operation consists of a visual and functional inspection of the internal components. A summary of the checks and/or maintenance operations that are essential for the correct operation of the product is provided below.

USER/TECHNICIAN	PARTS/FREQUENCY	1 DAY	2-3 DAYS	7 DAYS	15/20 DAYS	1 YEAR
UNDER THE USER'S RESPONSIBILITY	Brazier	X				
	Ash compartment **			X		
	Glass		X			
BY THE QUALIFIED TECHNICIAN	Upper exchanger					X
	Lower exchanger					X
	Smoke duct					X
	Gaskets					X
	Door closure operation					X

** Emptying of the ash compartment depends on various factors (pellet type, stove power, stove use, type of installation...); the exact emptying time will be suggested by experience.

14 IN CASE OF ANOMALY

14.1 PROBLEM SOLVING



























Before of every Authorized Technician intervention, the same Technician has the duty to check if the parameters of the mother board correspond to those of the table you own.



In case of doubts regarding the use of the stove, please contact ALWAYS the Authorized Technician on order to avoid irreparable damages!

PROBLEM	CAUSE	SOLUTION	INTERVENTION
The control display does not switch on	The stove is without power supply	Check if the plug is connected.	
	Burned protection fuse in the electric socket	Replace the protection fuses in the electric socket (3.15A-250V).	
	Faulty control display	Replace the control display.	
	Faulty flat cable	Replace the flat cable.	
	Faulty electronic board	Replace the mother board.	

PROBLEM	CAUSE	SOLUTION	INTERVENTION
Pellets do not reach the combustion chamber	Empty hopper	Full the hopper.	
	Open fire door or open pellet door	Close fire door and pellet door and check that there are no pellet grains at the gasket level.	
	Clogged stove	Fume chamber cleaning	
	Auger blocked by a foreign object (for example nails)	Clean the auger.	
	The auger geared motor is out of order	Replace the geared motor.	
	Check if on the display there is an "ACTIVE ALARM"	Have the stove checked.	
The fire extinguish and the stove stops	Empty hopper	Full the hopper.	
	Auger blocked by a foreign object (for example nails)	Clean the auger.	
	Bad quality pellets	Try other types of pellets.	
	Pellet drop value too low "phase 1"	Adjust the pellet loading.	
	Check if on the display there is an "ACTIVE ALARM"	Have the stove checked.	

PROBLEM	CAUSE	SOLUTION	INTERVENTION
Flames are weak and orange coloured, pellets do not burn properly and the glass blackens	Not sufficient combustion air	Check as following: probable obstructions of the combustible air inlet from the back or from the bottom of the stove; burning pot obstructed holes with too ash remains. Have the fan blades and auger cleaned. (see SMOKE RPM VARIATION User Manual)	
	Obstructed exhaust	The exhaust chimney is partially or totally obstructed. Contact an expert stove-repairer who checks the stove from the exhaust up to the chimney pot. Provide immediately for stove cleaning.	
	Obstructed stove	Provide immediately at the inner cleaning of the stove.	
	The fume fan is out of order	The pellets can burn also thanks to chimney flue depression without the aid of the fume fan. Have the fume fan immediately replaced. It can be noxious to health to let the stove running without fume fan.	
The exchanger fan continues to turn even though the stove has just cooled	Faulty fume temperature probe	Replace the fume probe.	
	Faulty mother board	Replace the mother board.	
Ash remains along the stove	Faulty or out of order door gaskets	Replace the gaskets.	
	Not sealed fume pipes	Contact an expert stove-repairer who will immediately provide for sealing the junctions with high-temperature silicone and/or for replacing pipes with those in compliance to current regulations. A not sealed fume channelisation can be noxious to health.	
The stove is at its highest power but does not heat up.	Ambient temperature reached.	The stove is at its minimum value. Increase the desired ambient temperature.	
Stove running and display showing "Smoke Overtemperature"	Reached fume outlet limit temperature	The stove runs at minimum. NO PROBLEM!	
The stove's smoke duct produces condensation	Low smoke temperature	Check that the flue is not clogged.	
		Increase stove power to minimum (pellet drop and fan revs).	
		Install condensation collection cup.	
Stove running and display showing "SERVICE"	Routine maintenance alert (it does not block the system)	When this flashing message appears upon start-up, it means that the preset operating hours have elapsed before maintenance. Contact the service centre.	

15 TECHNICAL DOCUMENTATION FOR LOCAL SPACE HEATERS ACCORDING TO COMMISSION REGULATIONS (EU) 2015/1185 - (EU) 2015/1186 (PRODUCT FI-CHE)

Manufacturer	CADEL srl - Via Foresto Sud 7 - 31025 Santa Lucia di Piave (TV) - Italy		
Trademark: model identifier	CADEL: SWEET3 7.0 - PERLA3 7.0 - CRISTAL 7.0 FREEPOINT: ONE AIRTIGHT - BEAM AIRTIGHT - ACCENT AIRTIGHT - ACCENT K AIRTIGHT- INDIGO EVO 7 PEGASO:VERA 7.0 - LORD7.0		
Description	Pellet stove		
Indirect heating functionality	No		
Direct heat output	7 kW		
Indirect heat output	- kW		
CPR harmonised standard	EN 14785		
Notified body	IMQ Spa (N.B.0051)		
Preferred fuel (unique)	Compressed wood with moisture content < 12 %	YES	
	Wood logs with moisture content ≤ 25 %	NO	
	Other woody biomass	NO	
η _s		86	%
EEI		126	-
Energy Efficiency Class (A++ to G scale)		A+	
Space heating emissions at nominal heat output	PM (al 13% O ₂)	15	mg/Nm ³
	OGC (al 13% O ₂)	1	mg/Nm ³
	CO (al 13% O ₂)	42	mg/Nm ³
	NO _x (al 13% O ₂)	117	mg/Nm ³
Space heating emissions at minimum heat output <i>Only required if correction factors F(2) or F(3) are applied</i>	PM (al 13% O ₂)	20	mg/Nm ³
	OGC (al 13% O ₂)	4	mg/Nm ³
	CO (al 13% O ₂)	238	mg/Nm ³
	NO _x (al 13% O ₂)	140	mg/Nm ³
Heat output	Nominal heat output (P _{nom})	7	kW
	Minimum heat output (indicative) (P _{min})	2,5	kW
Useful efficiency (NCV as received)	Useful efficiency at nominal heat output (η _{th, nom})	90	%
	Useful efficiency at minimum heat output (indicative) (η _{th, min})	91	%
Auxiliary electricity consumption	At nominal heat output (el _{max})	0,049	kW
	At minimum heat output (el _{min})	0,023	kW
	In standby mode (el _{sb})	0,002	kW
Type of heat output/room temperature control (select one)	Single stage heat output, no room temperature control	NO	
	Two or more manual stages, no room temperature control	NO	
	With mechanic thermostat room temperature control	NO	
	With electronic room temperature control	NO	
	With electronic room temperature control plus day timer	NO	
	With electronic room temperature control plus week timer	YES	
Other control options (multiple selections possible)	Room temperature control, with presence detection	NO	
	Room temperature control, with open window detection	NO	
	With distance control option	NO	
Permanent pilot flame power requirement	Pilot flame power requirement (if applicable) (P _{pilot})	N.A.	kW
Observe the specific precautions for installation, assembly and maintenance indicated in the manual accompanying the product.			
Issue date: 01.12.2021	Legal Representative	CADEL s.r.l. Via Foresto Sud, 7 - 31025 SANTA LUCIA DI PIAVE (TV) Tel. 0438 738869 - Fax 0438 73343 Partita IVA 03281180265 R.E.A. TV 227665 - Reg. Soc. Trib. TV 185949	

16 TECHNICAL DOCUMENTATION FOR LOCAL SPACE HEATERS ACCORDING TO COMMISSION REGULATIONS (EU) 2015/1185 - (EU) 2015/1186 (PRODUCT FICHE)

Manufacturer	CADEL srl - Via Foresto Sud 7 - 31025 Santa Lucia di Piave (TV) - Italy		
Trademark: model identifier	CADEL: CRISTAL3 7.0 UP FREEPOINT: SHARP AIRTIGHT-LEE AIRTIGHT PEGASO:VERA 7.0 UP		
Description	Pellet stove		
Indirect heating functionality	No		
Direct heat output	7 kW		
Indirect heat output	- kW		
CPR harmonised standard	EN 14785		
Notified body	IMQ Spa (N.B.0051)		
Preferred fuel (unique)	Compressed wood with moisture content < 12 %	YES	
	Wood logs with moisture content ≤ 25 %	NO	
	Other woody biomass	NO	
η_s		86	%
EEI		126	-
Energy Efficiency Class (A++ to G scale)		A+	
Space heating emissions at nominal heat output	PM (al 13% O ₂)	15	mg/Nm ³
	OGC (al 13% O ₂)	1	mg/Nm ³
	CO (al 13% O ₂)	42	mg/Nm ³
	NO _x (al 13% O ₂)	117	mg/Nm ³
Space heating emissions at minimum heat output <i>Only required if correction factors F(2) or F(3) are applied</i>	PM (al 13% O ₂)	20	mg/Nm ³
	OGC (al 13% O ₂)	4	mg/Nm ³
	CO (al 13% O ₂)	238	mg/Nm ³
	NO _x (al 13% O ₂)	140	mg/Nm ³
Heat output	Nominal heat output (P _{nom})	7	kW
	Minimum heat output (indicative) (P _{min})	2,5	kW
Useful efficiency (NCV as received)	Useful efficiency at nominal heat output ($\eta_{th, nom}$)	90	%
	Useful efficiency at minimum heat output (indicative) ($\eta_{th, min}$)	91	%
Auxiliary electricity consumption	At nominal heat output (el _{max})	0,049	kW
	At minimum heat output (el _{min})	0,023	kW
	In standby mode (el _{sb})	0,002	kW
Type of heat output/room temperature control (select one)	Single stage heat output, no room temperature control	NO	
	Two or more manual stages, no room temperature control	NO	
	With mechanic thermostat room temperature control	NO	
	With electronic room temperature control	NO	
	With electronic room temperature control plus day timer	NO	
Other control options (multiple selections possible)	With electronic room temperature control plus week timer	YES	
	Room temperature control, with presence detection	NO	
	Room temperature control, with open window detection	NO	
Permanent pilot flame power requirement	With distance control option	NO	
	Pilot flame power requirement (if applicable) (P _{pilot})	N.A.	kW
Observe the specific precautions for installation, assembly and maintenance indicated in the manual accompanying the product.			
Issue date: 01.12.2021	Legal Representative	CADEL s.r.l. Via Foresto Sud, 7 - 31026 SANTA LUCIA DI PIAVE (TV) Tel. 0438 738469 - Fax 0438 73343 Partita IVA 03281130265 R.E.A. TV 227665 - Reg. Soc. Trib. TV 185949	

17 TECHNICAL DOCUMENTATION FOR LOCAL SPACE HEATERS ACCORDING TO COMMISSION REGULATIONS (EU) 2015/1185 - (EU) 2015/1186 (PRODUCT FICHE)

Manufacturer	CADEL srl - Via Foresto Sud 7 - 31025 Santa Lucia di Piave (TV) - Italy		
Trademark: model identifier	CADEL: SOUND3 5 UP FREEPOINT: CHROME5 AIRTIGHT- ROUN5 AIRTIGHT PEGASO: FLOYD 5.0		
Description	Pellet stove		
Indirect heating functionality	No		
Direct heat output	5,5 kW		
Indirect heat output	- kW		
CPR harmonised standard	EN 14785		
Notified body	IMQ Spa (N.B.0051)		
Preferred fuel (unique)	Compressed wood with moisture content < 12 %	YES	
	Wood logs with moisture content ≤ 25 %	NO	
	Other woody biomass	NO	
η_s		86	%
EEI		126	-
Energy Efficiency Class (A++ to G scale)		A+	
Space heating emissions at nominal heat output	PM (al 13% O ₂)	15	mg/Nm ³
	OGC (al 13% O ₂)	2	mg/Nm ³
	CO (al 13% O ₂)	140	mg/Nm ³
	NO _x (al 13% O ₂)	129	mg/Nm ³
Space heating emissions at minimum heat output <i>Only required if correction factors F(2) or F(3) are applied</i>	PM (al 13% O ₂)	20	mg/Nm ³
	OGC (al 13% O ₂)	4	mg/Nm ³
	CO (al 13% O ₂)	238	mg/Nm ³
	NO _x (al 13% O ₂)	140	mg/Nm ³
Heat output	Nominal heat output (P _{nom})	5,5	kW
	Minimum heat output (indicative) (P _{min})	2,5	kW
Useful efficiency (NCV as received)	Useful efficiency at nominal heat output ($\eta_{th, nom}$)	90	%
	Useful efficiency at minimum heat output (indicative) ($\eta_{th, min}$)	91	%
Auxiliary electricity consumption	At nominal heat output (el _{max})	0,049	kW
	At minimum heat output (el _{min})	0,023	kW
	In standby mode (el _{sb})	0,002	kW
Type of heat output/room temperature control (select one)	Single stage heat output, no room temperature control	NO	
	Two or more manual stages, no room temperature control	NO	
	With mechanic thermostat room temperature control	NO	
	With electronic room temperature control	NO	
	With electronic room temperature control plus day timer	NO	
Other control options (multiple selections possible)	With electronic room temperature control plus week timer	YES	
	Room temperature control, with presence detection	NO	
	Room temperature control, with open window detection	NO	
Permanent pilot flame power requirement	With distance control option	NO	
	Pilot flame power requirement (if applicable) (P _{pilot})	N.A.	kW
Observe the specific precautions for installation, assembly and maintenance indicated in the manual accompanying the product.			
Issue date: 01.12.2021	Legal Representative	CADEL s.r.l. Via Foresto Sud, 7 - 31026 SANTA LUCIA DI PIAVE (TV) Tel. 0438 738469 - Fax 0438 73343 Partita IVA 03281130265 R.E.A. TV 227665 - Reg. Soc. Trib. TV 185949	

18 TECHNICAL DOCUMENTATION FOR LOCAL SPACE HEATERS ACCORDING TO COMMISSION REGULATIONS (EU) 2015/1185 - (EU) 2015/1186 (PRODUCT FICHE)

Manufacturer	CADEL srl - Via Foresto Sud 7 - 31025 Santa Lucia di Piave (TV) - Italy		
Trademark: model identifier	CADEL: SOUND3 7 UP FREEPOINT: CHROME7 AIRTIGHT- ROUND7 AIRTIGHT PEGASO: FLOYD 7.0		
Description	Pellet stove		
Indirect heating functionality	No		
Direct heat output	7 kW		
Indirect heat output	- kW		
CPR harmonised standard	EN 14785		
Notified body	IMQ Spa (N.B.0051)		
Preferred fuel (unique)	Compressed wood with moisture content < 12 %	YES	
	Wood logs with moisture content ≤ 25 %	NO	
	Other woody biomass	NO	
η_s		86	%
EEI		126	-
Energy Efficiency Class (A++ to G scale)		A+	
Space heating emissions at nominal heat output	PM (al 13% O ₂)	15	mg/Nm ³
	OGC (al 13% O ₂)	1	mg/Nm ³
	CO (al 13% O ₂)	42	mg/Nm ³
	NO _x (al 13% O ₂)	117	mg/Nm ³
Space heating emissions at minimum heat output <i>Only required if correction factors F(2) or F(3) are applied</i>	PM (al 13% O ₂)	20	mg/Nm ³
	OGC (al 13% O ₂)	4	mg/Nm ³
	CO (al 13% O ₂)	238	mg/Nm ³
	NO _x (al 13% O ₂)	140	mg/Nm ³
Heat output	Nominal heat output (P _{nom})	7	kW
	Minimum heat output (indicative) (P _{min})	2,5	kW
Useful efficiency (NCV as received)	Useful efficiency at nominal heat output ($\eta_{th,nom}$)	90	%
	Useful efficiency at minimum heat output (indicative) ($\eta_{th,min}$)	91	%
Auxiliary electricity consumption	At nominal heat output (el _{max})	0,049	kW
	At minimum heat output (el _{min})	0,023	kW
	In standby mode (el _{sb})	0,002	kW
Type of heat output/room temperature control (select one)	Single stage heat output, no room temperature control	NO	
	Two or more manual stages, no room temperature control	NO	
	With mechanic thermostat room temperature control	NO	
	With electronic room temperature control	NO	
	With electronic room temperature control plus day timer	NO	
Other control options (multiple selections possible)	With electronic room temperature control plus week timer	YES	
	Room temperature control, with presence detection	NO	
	Room temperature control, with open window detection	NO	
Permanent pilot flame power requirement	With distance control option	NO	
	Pilot flame power requirement (if applicable) (P _{pilot})	N.A.	kW
Observe the specific precautions for installation, assembly and maintenance indicated in the manual accompanying the product.			
Issue date: 01.12.2021	Legal Representative	CADEL s.r.l. Via Foresto Sud, 7 - 31026 SANTA LUCIA DI PIAVE (TV) Tel. 0438 738469 - Fax 0438 73343 Partita IVA 03281130265 R.E.A. TV 227665 - Reg. Soc. Trib. TV 185949	

19 TECHNICAL DOCUMENTATION FOR LOCAL SPACE HEATERS ACCORDING TO COMMISSION REGULATIONS (EU) 2015/1185 - (EU) 2015/1186 (PRODUCT FICHE)

Manufacturer	CADEL srl - Via Foresto Sud 7 - 31025 Santa Lucia di Piave (TV) - Italy		
Trademark: model identifier	CADEL: CRISTAL 9 T1 FREEPOINT: LIFE 9 T1 - AMARANTO 9 T1 PEGASO: ELANE 9 T1		
Description	Pellet stove		
Indirect heating functionality	No		
Direct heat output	8,5 kW		
Indirect heat output	- kW		
CPR harmonised standard	EN 14785		
Notified body	IMQ Spa (N.B.0051)		
Preferred fuel (unique)	Compressed wood with moisture content < 12 %	YES	
	Wood logs with moisture content ≤ 25 %	NO	
	Other woody biomass	NO	
η_s		85	%
EEI		125	-
Energy Efficiency Class (A++ to G scale)		A+	
Space heating emissions at nominal heat output	PM (al 13% O ₂)	15	mg/Nm ³
	OGC (al 13% O ₂)	3	mg/Nm ³
	CO (al 13% O ₂)	160	mg/Nm ³
	NO _x (al 13% O ₂)	130	mg/Nm ³
Space heating emissions at minimum heat output <i>Only required if correction factors F(2) or F(3) are applied</i>	PM (al 13% O ₂)	20	mg/Nm ³
	OGC (al 13% O ₂)	5	mg/Nm ³
	CO (al 13% O ₂)	297	mg/Nm ³
	NO _x (al 13% O ₂)	120	mg/Nm ³
Heat output	Nominal heat output (P _{nom})	8,5	kW
	Minimum heat output (indicative) (P _{min})	2,5	kW
Useful efficiency (NCV as received)	Useful efficiency at nominal heat output ($\eta_{th, nom}$)	89	%
	Useful efficiency at minimum heat output (indicative) ($\eta_{th, min}$)	90	%
Auxiliary electricity consumption	At nominal heat output (el _{max})	0,096	kW
	At minimum heat output (el _{min})	0,014	kW
	In standby mode (el _{sb})	0,001	kW
Type of heat output/room temperature control (select one)	Single stage heat output, no room temperature control	NO	
	Two or more manual stages, no room temperature control	NO	
	With mechanic thermostat room temperature control	NO	
	With electronic room temperature control	NO	
	With electronic room temperature control plus day timer	NO	
Other control options (multiple selections possible)	With electronic room temperature control plus week timer	YES	
	Room temperature control, with presence detection	NO	
	Room temperature control, with open window detection	NO	
Permanent pilot flame power requirement	With distance control option	NO	
	Pilot flame power requirement (if applicable) (P _{pilot})	N.A.	kW
Observe the specific precautions for installation, assembly and maintenance indicated in the manual accompanying the product.			
Issue date: 08.02.2022	Legal Representative	CADEL s.r.l. Via Foresto Sud, 7 - 31026 SANTA LUCIA DI PIAVE (TV) Tel. 0438 738469 - Fax 0438 73343 Partita IVA 03281130265 R.E.A. TV 227665 - Reg. Soc. Trib. TV 185949	

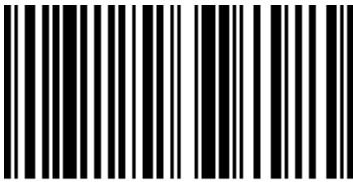

89022076A

Rev. 00-2023

CADEL srl
31025 S. Lucia di Piave - TV
Via Martiri della Libertà, 74 - Italy
Tel. +39 0438 1520200

www.cadelsrl.com
www.free-point.it
www.pegasoheating.com